



**RG series: 1-phase solid state switching solutions**

**Switches**

# RG series

## A new generation of solid state switches

The RG series is the latest addition to the range of Solid State Relays (SSRs) and Solid State Contactors (SSCs) offered by Carlo Gavazzi. With this series, Carlo Gavazzi continues to distinguish itself as a leader in Solid State Switching by introducing the first SSR and SSC in the smallest DIN dimension of 17.5 mm.

The RG series adopts an innovative thermal efficient design which translates to compact solutions available throughout the RG range. Panel space savings up to 25% is possible with RG solid state relays. The wire bonding technology used for the output chip assembly reduces thermal and mechanical stress providing a longer lifetime for the solid state switch.

Manufacturing of the RG series is done in an ISO9001 facility which is also certified for ISO14001.



## Enhanced reliability and panel space optimisation

### Solid state relays: RGS1 series

These solutions do not have an integrated heatsink. The size and design of the heatsink, if required, is determined by the end user for the specific application where the SSR is to be used.

Carlo Gavazzi offers a range of heatsinks suitable for DIN, panel or thru wall mounting. Our Heatsink Selector Tool is available on our website: [www.gavazziautomation.com](http://www.gavazziautomation.com) and can be used for the selection of the most appropriate Carlo Gavazzi heatsink for the intended application.

### Solid state contactors: RGC1, RGH1 series

These are out of the box ready to use solutions that have a factory mounted heatsink. Each product variant has a current derating curve that gives the maximum operational current at a specific working temperature.

Such solutions eliminate the need for the end user to calculate the heatsinking required for the correct operation of the solid state switch.

Additionally, these solutions are not approved as components but bear the UL listed mark instead of the UR mark.



## Benefits

### Long lifetime, less maintenance costs

Thermal stress on the semiconductor is eliminated with the introduction of wire bonding. SSR lifetime is increased by 2 to 3 times as compared to other SSRs using only die solder technology



### Low downtime

The switching of AC loads in the RG range is done with **back-to-back thyristors** which are well known for their superior specifications compared to other switching components.

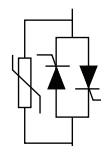

The **integrated varistor** across the output of the solid state switch provides adequate protection against uncontrolled overvoltages. There is no need to connect this externally for conformance to the surge immunity test according to EN 61000-4-5



### Easy and fast installation

- Integrated heatsink with the RGC series
- Pluggable spring connectors for the input terminals
- Box clamp variants provide robust connections for easy and fast connection of power cables up to 25 mm<sup>2</sup> / AWG 3



### Space saving

The slimmest product in the range has a product width of only **17.5 mm** giving 25% space saving per SSR compared to the 22.5 mm solutions.



### Short circuit protection with MCBs

The I<sup>2</sup>t specification in the RG range goes up to **18,000 A<sup>2</sup>s** in only 17.5 mm product width. The RG with 18,000 A<sup>2</sup>s is the ideal solution when protection of the SSR against short circuits with economic, easily accessible, Miniature Circuit Breakers is desired.



### High UL fault current rating for panels

Industrial Control Panels designed according to UL508A need to have a short circuit current rating (SCCR) marking based on the lowest SCCR of the components used inside the panel. With **100 kArms** SCCR for the RG series, Carlo Gavazzi SSRs are no limitation to panel builders needing a high SCCR marking on their panels.



UL 508A  
Industrial  
Control Panels

# RG series

## A complete product offering

### Space saving solid state switching solutions for AC loads

#### RGS1 series

- 17.5mm product width
- Zero cross or Instant on
- Ratings up to 660 VAC, 90 AAC\*
- Blocking voltage up to 1600 Vp
- 18,000 A<sup>2</sup>s for MCB protection
- AC or DC control

#### RGC1 series, RGH1 series

- Integrated heatsink
- Zero cross or Instant on (RGC1)
- Ratings up to 660 VAC, 85 AAC\*
- Blocking voltage 1200 Vp, 1600 Vp (RGH1)
- 18,000 A<sup>2</sup>s for MCB protection
- AC or DC control
- Optional overtemperature protection



### 1000 VDC switching solutions in 17.5 mm product width

#### RGS1D series

- Ratings up to 1000 VDC, 25 ADC
- DC control

#### RGC1D series

- Integrated heatsink
- Ratings up to 1000 VDC, 15 ADC
- DC control



### Fit and forget - Integrated fuse protection and system monitoring

#### RGC1FA series

- Integrated heatsink
- On-board semiconductor fuse
- Zero cross
- Ratings up to 660 VAC, 40 AAC
- DC control

#### RGC1FS series

- Integrated heatsink
- On-board semiconductor fuse
- Monitoring for open fuse, heater loss, SSR malfunction
- Zero cross
- Ratings up to 660 VAC, 40 AAC
- DC control



### Monitor changes in heater characteristics with the RG current sensing

#### RGS1S series

- 1/6 partial load failure
- Loadloss, Mainsloss, overtemperature and SSR malfunction detection
- Zero cross
- Ratings up to 660 VAC, 90 AAC
- DC control

#### RGC1S series

- Integrated heatsink
- 1/6 partial load failure
- Loadloss, Mainsloss, overtemperature and SSR malfunction detection
- Zero cross
- Ratings up to 660 VAC, 85 AAC
- DC control



### Power control with analog input solid state switches

#### RGS1P..AA, RGS1P..V series

- Phase angle, full cycle, advanced full cycle or soft start switching
- Ratings up to 660 VAC, 90 AAC
- 4-20mA, 0-10V, 1-5V, 0-5V, pot input

#### RGC1P..AA, RGC1P..V series

- Integrated heatsink
- Phase angle, full cycle, advanced full cycle or soft start switching
- Ratings up to 660 VAC, 63 AAC
- 4-20mA, 0-10V, 1-5V, 0-5V, pot input



### Soft starting solution for SWIR heaters

#### RGS1P..K series

- Soft start switching
- Ratings up to 660 VAC, 90 AAC
- 24 VDC control

#### RGC1P..K series

- Integrated heatsink
- Soft start switching
- Ratings up to 660 VAC, 63 AAC
- 24 VDC control



\* RGS and RGH models are available up to 690 VAC nominal operational voltage. These variants are CE marked only and do not have an integrated varistor

## Applications

### Plastic & Rubber

- Extrusion machines
- Blow moulding equipment
- Auxiliary equipment
- Plastic injection machines
- Film blow moulding
- Thermoforming

#### Benefits

- Trouble free operation over a large number of cycles
- Panel space optimisation with the RG small footprint
- UL listing facilitates equipment certification process
- 100 kArms short circuit current rating enables high fault rating for UL 508A panels

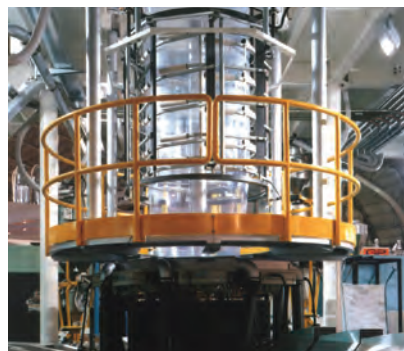

### Food & Beverage

- Electrical ovens
- Vending machines
- Fryers
- Coffee machines
- Griddles

#### Benefits

- Reliable operation in humid environments of 95% @ 40 °C (104 °F)
- Conformance to legislation for restricted substances (RoHS)
- Glow wire flammability ratings for plastics conform to EN 60335 requirements



### HVAC

- Air duct heaters
- Air handling units
- Dehumidifiers
- Underfloor heating

#### Benefits

- Long lifetime with a fully solid state solution
- Power control with an analog input fed directly to the RGC
- No annoying clicking sound (unlike with mechanical solutions)
- Energy efficiency with RGC1P phase angle mode for speed control of AC fans



### Packaging & Wrapping

- Sealing process
- Sterilisation
- Shrink wrapping

#### Benefits

- Low downtime, less maintenance costs with integrated overvoltage protection
- Fast to install
- 18,000 A<sup>2</sup>s facilitates short circuit protection coordination



### Semiconductor

- Soldering machines
- Drying

#### Benefits

- Long operating lifetime
- Space saving with the RG slim solutions
- Fault diagnostics with optional load and system monitoring
- Energy efficiency with power control solutions



# Slimline RG

## RGS series

In most cases, when utilising a solid state relay, a heatsink is required for heat dissipation. The size and shape of the heatsink is dictated by the specific application and is not always to be fitted in standard sized industrial control panels.

The RGS series does not have integrated heatsink and so allows end users to design and adapt their own heatsinking solutions. Different heatsinks on which the RGS can be fitted are available from Carlo Gavazzi. Our Heatsink Selector Tool is available on our website: [www.gavazziautomation.com](http://www.gavazziautomation.com)

All variants in the RGS series are available in a platform with a product width of 17,5 mm.



## AC output solid state relays

### RGS series

- 17.5 mm product width
- Ratings up to 660 VAC, 90 AAC\*
- Zero cross or Instant ON (Random) switching
- I<sup>2</sup>t up to 18,000 A<sup>2</sup>s
- Control range: 4-32 VDC, 20-275 VAC (24-190 VDC)
- Integrated varistor across output\*
- Motor ratings up to 4 kW (400 VAC), 15 HP (600 VAC)
- 100 kArms short circuit current rating acc. to UL 508
- 'E' type or 'U' type configuration
- Box clamps for 25 mm<sup>2</sup> / AWG 3 power cables
- Spring loaded control plug option

### Mounting of RGS

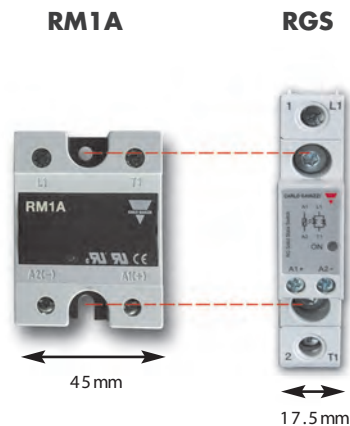

Identical mounting hole spacing specifications



\* Options available for 690 VAC nominal operational voltage with CE marking only and no integrated varistor

## Applications



### DIN mounting

RGS1 solid state relay can be DIN mounted by means of the **RGS1DIN** accessory. RGS1 rating up to 12 AAC @ 40 °C (104 °F) when mounted on RGS1DIN



### RGS Power Pack

A pack with maximum 11x RGS1 on heatsink with integrated overheat protection. Rating per SSR goes up to 30 AAC @ 40 °C (104 °F)



### Thermal pads

An alternative to thermal paste: the **RGHT** is a pack of 10 thermal pads. Add suffix 'HT', (RGS...HT), for factory mounted thermal pad

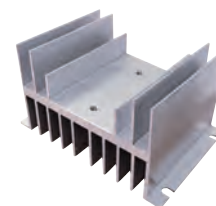

### Heatsinks

A number of heatsinks are available for mounting the RGS on different type of heatsinks such as thru wall mount heatsinks and panel mount heatsinks.

## Selection guide

### 'E' type configurations

Rated voltage, Blocking voltage, Switching mode	Connection control/ power	Control voltage	25 AAC (525 A <sup>2</sup> s) 17.5 mm	50 AAC (1800 A <sup>2</sup> s) 17.5 mm	75 AAC (3200 A <sup>2</sup> s) 17.5 mm	90 AAC (6600 A <sup>2</sup> s) 17.5 mm	90 AAC (18000 A <sup>2</sup> s) 17.5 mm
230 VAC, 800 Vp ZC	x / Screw	3 - 32 VDC	RGS1A23D25xKE	RGS1A23D50xKE	-	-	-
		20 - 275 VAC (24 - 190 VDC)	RGS1A23A25xKE	RGS1A23A50xKE	-	-	-
600 VAC, 1200 Vp ZC	x / Screw	4 - 32 VDC	RGS1A60D25xKE	RGS1A60D50xKE	RGS1A60D75KKE	RGS1A60D90xKE	RGS1A60D92xKE
		20 - 275 VAC (24 - 190 VDC)	RGS1A60A25xKE	RGS1A60A50xKE	RGS1A60A75KKE	RGS1A60A90xKE	RGS1A60A92xKE
	x / Box	4 - 32 VDC	-	RGS1A60D50xGE	-	-	RGS1A60D92xGE
		20 - 275 VAC (24 - 190 VDC)	-	RGS1A60A50KGE	-	-	RGS1A60A92KGE
600 VAC, 1600 Vp ZC	Screw / Screw	4 - 32 VDC	-	RGS1A60D51KKE	-	RGS1A60D91KKE*	-
		20 - 275 VAC (24 - 190 VDC)	-	RGS1A60A51KKE	-	RGS1A60A91KKE*	-
600 VAC, 1200 Vp IO	Screw / Screw	4 - 32 VDC	-	RGS1B60D50KKE	-	RGS1B60D90KKE	-

### 'U' type configurations

Rated voltage, Blocking voltage, Switching mode	Connection control/ power	Control voltage	30 AAC (1800 A <sup>2</sup> s) 17.5 mm	-	-	-	-
600 VAC, 1200 Vp ZC	Screw / Box	4 - 32 VDC	RGS1A60D30KGU	-	-	-	-
		20 - 275 VAC (24 - 190 VDC)	RGS1A60A30KGU	-	-	-	-
600 VAC, 1200 Vp IO	Screw / Box	4 - 32 VDC	RGS1B60D30KGU	-	-	-	-

x = control connection type, x = 'K' for screw, x = 'M' for spring

ZC = Zero Cross Switching, IO = Instant On Switching

\* Similar models are available for 690 VAC rated voltage

Further details are available on online datasheets at [www.productselection.net](http://www.productselection.net)

CARLO GAVAZZI Automation Components. Specifications are subject to change without notice. Illustrations are for example only.

# Slimline RG

## RGC and RGH series

Unlike the RGS series, the RGC and RGH have integrated heatsink and hence are referred to as ready to use solutions since end users do not need to calculate and mount the solid state switch on an additional heatsink.

Because of this, each variant in the RGC and RGH series has an associated current rating at a specific working ambient temperature that is determined by the size of the heatsink of that particular model. The physical sizes and hence ratings in the RGC and RGH series are dictated by the size of the heatsink.

The smallest product in the RGC and RGH range is a product with 17.5 mm width and associated rating goes up to 37 AAC @ 40 °C (104 °F). Product width in the RGC, RGH range goes up to 70mm extending the series to a maximum rating of 85 AAC @ 40 °C (104 °F).

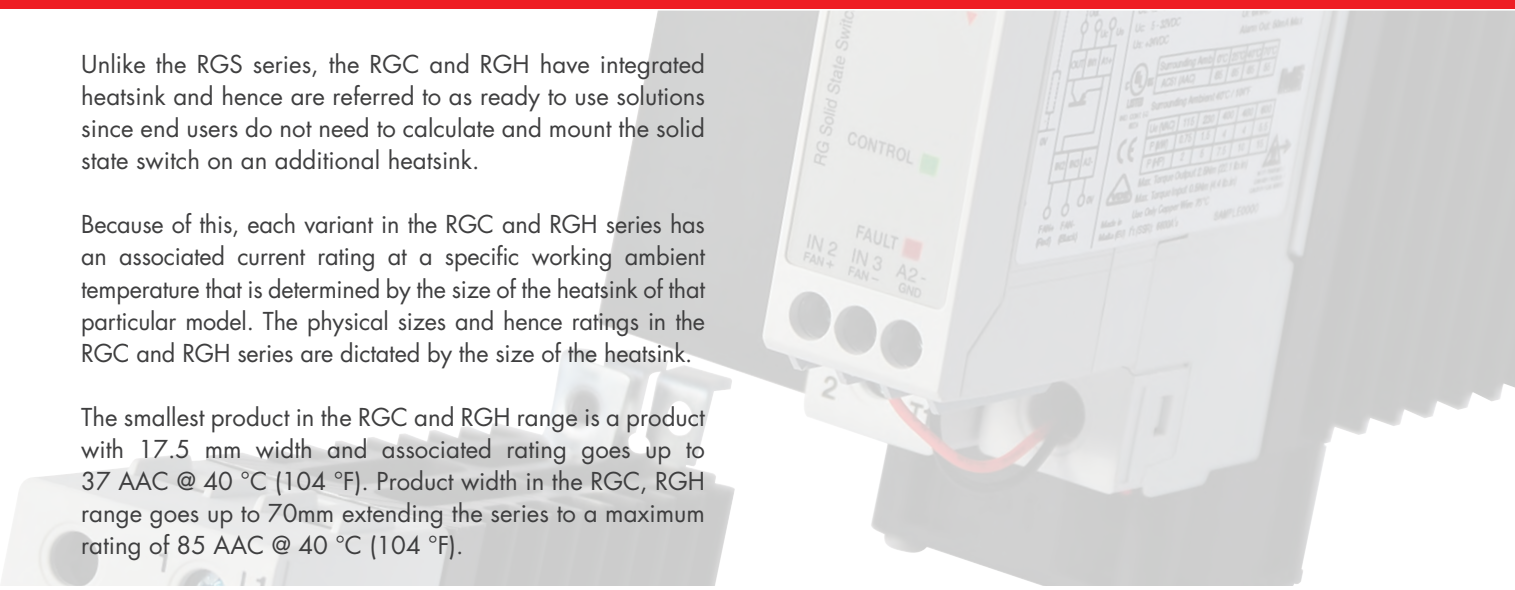

## AC output solid state contactors

### RGC series

- 1200 Vp blocking voltage;  $I^2t$  up to 18,000 A<sup>2</sup>s
- Current ratings at 40 °C (104 °F) up to 85 AAC
- Operational voltage up to 660 VAC
- Zero cross or Instant ON (Random) switching
- Control range: 4-32 VDC, 20-275 VAC (24-190 VDC)
- Integrated varistor across output
- Motor ratings up to 4.4 kW (400 VAC), 15 HP (600 VAC)
- 100 kArms short circuit current rating acc. to UL 508
- 'E' type or 'U' type configuration
- Spring loaded control plug option
- Optional overtemperature protection

### RGH series

- 1600 Vp blocking voltage;  $I^2t$  up to 6,600 A<sup>2</sup>s
- Current ratings at 40 °C (104 °F) up to 60 AAC
- Operational voltage up to 660 VAC\*\*
- Zero cross switching
- Control range: 4-32 VDC, 20-275 VAC (24-190 VDC)
- Integrated varistor across output\*\*
- Motor ratings up to 4.4 kW (400 VAC), 15 HP (600 VAC)
- 100 kArms short circuit current rating acc. to UL 508
- 'E' type or 'U' type configuration
- Spring loaded control plug option



\* GL applies only to RGC..15, RGC..20, RGC..25, RGC..30

\*\*Options available for 690 VAC rated voltage with CE marking only and no integrated varistor



## Selection guide

### ‘E’ type configurations

		Power connection: Screw ‘K’						
Rated voltage, Blocking voltage, Switching mode	Control voltage	20 AAC (525 A <sup>2</sup> s) 17.5 mm - Short	23 AAC (6600 A <sup>2</sup> s) 17.5 mm - Short	25 AAC (1800 A <sup>2</sup> s) 17.5 mm - Short	30 AAC (18000 A <sup>2</sup> s) 17.5 mm - Short	30 AAC (1800 A <sup>2</sup> s) 22.5 mm	30 AAC (6600 A <sup>2</sup> s) 22.5 mm	-
		230 VAC, 800 Vp ZC	3 - 32 VDC	RGCI A23D15xKE	-	RGCI A23D25xKE	-	RGCI A23D30xKE
	20 - 275 VAC (24 - 190 VDC)	RGCI A23A15xKE	-	RGCI A23A25xKE	-	RGCI A23A30xKE	-	-
600 VAC, 1200 Vp ZC	4 - 32 VDC	RGCI A60D15xKE	-	RGCI A60D25xKE	RGCI A60D32xKE	RGCI A60D30xKE	-	-
	20 - 275 VAC (24 - 190 VDC)	RGCI A60A15xKE	-	RGCI A60A25xKE	-	RGCI A60A30xKE	-	-
600 VAC, 1600 Vp ZC	4 - 32 VDC	-	RGH1 A60D15xKE	-	-	-	RGH1 A60D31xKE	-
	20 - 275 VAC (24 - 190 VDC)	-	RGH1 A60A15xKE	-	-	-	RGH1 A60A31xKE	-
600 VAC, 1200 Vp, IO	4 - 32 VDC	RGCI B60D15KKE	-	RGCI B60D25KKE	-	RGCI B60D30KKE	-	-

		Power connection: Box ‘G’						
Rated voltage, Blocking voltage, Switching mode	Control voltage	37 AAC (18000 A <sup>2</sup> s) 17.5 mm - Short	40 AAC (3200 A <sup>2</sup> s) 35 mm	40 AAC (6600 A <sup>2</sup> s) 35 mm	43 AAC (18000 A <sup>2</sup> s) 35 mm	60 AAC (3200 A <sup>2</sup> s) 70 mm	60 AAC (6600 A <sup>2</sup> s) 70 mm	65 AAC (18000 A <sup>2</sup> s) 70 mm
		230 VAC, 800 Vp ZC	3 - 32 VDC	-	RGCI A23D40KGE	-	RGCI A23D42KGE	RGCI A23D60KGE
	20 - 275 VAC (24 - 190 VDC)	-	RGCI A23A40KGE	-	RGCI A23A42KGE	RGCI A23A60KGE	-	RGCI A23A62KGE
600 VAC, 1200 Vp ZC	4 - 32 VDC	RGCI A60D32xGE	RGCI A60D40xGE	-	RGCI A60D42xGE	RGCI A60D60KGE	-	RGCI A60D62xGE
	20 - 275 VAC (24 - 190 VDC)	-	RGCI A60A40xGE	-	RGCI A60A42xGE	RGCI A60A60KGE	-	RGCI A60A62xGE
600 VAC, 1600 Vp ZC	4 - 32 VDC	-	-	RGH1 A60D41xGE*	-	-	RGH1 A60D60KGE*	-
	20 - 275 VAC (24 - 190 VDC)	-	-	RGH1 A60A41xGE*	-	-	RGH1 A60A60KGE*	-
600 VAC, 1200 Vp, IO	4 - 32 VDC	-	RGCI B60D40KGE	-	RGCI B60D42KGE	RGCI B60D60KGE	-	RGCI B60D62KGE

### ‘U’ type configurations

		Power connection: Box ‘G’						
Rated voltage, Blocking voltage, Switching mode	Control voltage	20 AAC (525 A <sup>2</sup> s) 17.5 mm - Short	25 AAC (1800 A <sup>2</sup> s) 17.5 mm - Short	30 AAC (1800 A <sup>2</sup> s) 22.5 mm	-	-	-	-
		230 VAC, 800 Vp ZC	3 - 32 VDC	RGCI A23D15KGU	RGCI A23D25KGU	RGCI A23D30KGU		
	20 - 275 VAC (24 - 190 VDC)	RGCI A23A15KGU	RGCI A23A25KGU	RGCI A23A30KGU				
600 VAC, 1200 Vp ZC	4 - 32 VDC	RGCI A60D15KGU	RGCI A60D25KGU	RGCI A60D30KGU				
	20 - 275 VAC (24 - 190 VDC)	RGCI A60A15KGU	RGCI A60A25KGU	RGCI A60A30KGU				
600 VAC, 1200 Vp, IO	4 - 32 VDC	RGCI B60D15KGU	RGCI B60D25KGU	RGCI B60D30KGU				

		Power connection: Box ‘G’						
Rated voltage, Blocking voltage, Switching mode	Control voltage	-	40 AAC (3200 A <sup>2</sup> s) 35 mm	40 AAC (6600 A <sup>2</sup> s) 35 mm	43 AAC (18000 A <sup>2</sup> s) 35 mm	60 AAC (3200 A <sup>2</sup> s) 70 mm	60 AAC (6600 A <sup>2</sup> s) 70 mm	65 AAC (18000 A <sup>2</sup> s) 70 mm
		600 VAC, 1200 Vp ZC	4 - 32 VDC	-	RGCI A60D40KGU	-	RGCI A60D42KGU	RGCI A60D60KGU
	20 - 275 VAC (24 - 190 VDC)	-	RGCI A60A40KGU	-	RGCI A60A42KGU	RGCI A60A60KGU	-	RGCI A60A62KGU
600 VAC, 1600 Vp ZC	4 - 32 VDC	-	-	RGH1 A60D41KGU	-	-	RGH1 A60D60KGU	-
	20 - 275 VAC (24 - 190 VDC)	-	-	RGH1 A60A41KGU	-	-	RGH1 A60A60KGU	-
600 VAC, 1200 Vp, IO	4 - 32 VDC	-	RGCI B60D40KGU	-	RGCI B60D42KGU	RGCI B60D60KGU	-	RGCI B60D62KGU

### Integrated over temperature protection

Rated voltage, Blocking voltage, Switching mode	Control voltage	30 AAC (1800 A <sup>2</sup> s) 22.5 mm	40 AAC (3200 A <sup>2</sup> s) 35 mm	43 AAC (18000 A <sup>2</sup> s) 35 mm	60 AAC (3200 A <sup>2</sup> s) 70 mm	65 AAC (18000 A <sup>2</sup> s) 70 mm	85 AAC (6600 A <sup>2</sup> s) 70 mm + fan	85 AAC (18000 A <sup>2</sup> s) 70 mm + fan
		600VAC, 1200Vp ZC	5 - 32 VDC	RGCI A60D30GKEP	RGCI A60D40GGUP	RGCI A60D42GGEP	RGCI A60D60GGUP	RGCI A60D62GGEP
	20 - 275VAC (24 - 190 VDC)	RGCI A60A30GKEP	RGCI A60A40GGUP	RGCI A60A42GGEP	RGCI A60A60GGUP	RGCI A60A62GGEP	RGCI A60A90GGzP	RGCI A60A92GGEP

x = control connection type, x = ‘K’ for screw, x = ‘M’ for spring  
z = Type Configuration, z = ‘E’ for E-type layout, z = ‘U’ for U-type layout  
ZC = Zero Cross Switching, IO = Instant On Switching  
\* Similar models are available for 690 VAC rated voltage  
Further details are available on online datasheets at [www.productselection.net](http://www.productselection.net)

# Current sensing

## RGC1S and RGS1S series

The RG Current Sensing (CS) series is able to detect variations in the load current thanks to its integrated current measurement. The load current to be used as a reference is set and recorded through a TEACH procedure which can be done either locally or remotely.

During operation, the actual load current is compared to the set point and if a deviation  $>16.67\%$  ( $1/6$ ) is observed an alarm is issued to signal a partial load failure. This feature allows 6 loads to be connected to one solid state switch and have a detection of load failure in case only one of the loads fail.

Upon issue of the partial load failure alarm, the output of the solid state switch is not inhibited and so the remaining loads connected to the RGC1S or RGS1S can be switched as dictated by the specific process.



## Plug and play

### RGC1S series

- Integrated heatsink
- Partial load failure detection 1/6
- Ratings up to 660 VAC, 85 AAC @ 40 °C (104 °F)
- $I^2t$  up to 18,000 A<sup>2</sup>s
- 4-32 VDC control voltage range
- Integrated varistor for overvoltage protection
- 100 kArms short circuit current rating acc. to UL 508



### RGS1S series

- Product width 22.5 mm, heatsink not integrated
- Partial load failure detection 1/6
- Ratings up to 660 VAC, 90 AAC, 18,000 A<sup>2</sup>s
- 4-32 VDC control voltage range
- Integrated varistor for overvoltage protection
- 100 kArms short circuit current rating acc. to UL 508



**Switches**

### Mounting of the RGS1S on a heatsink

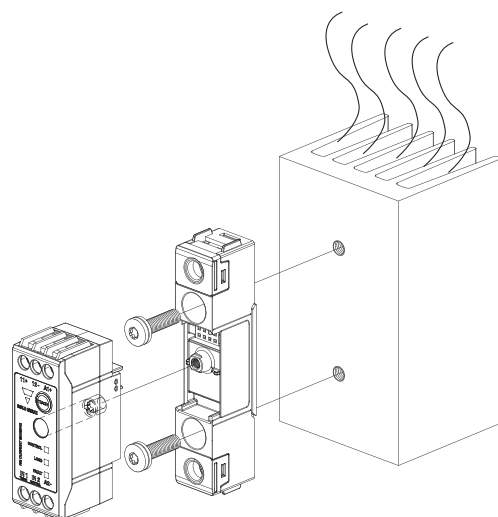

## Partial load failure detection

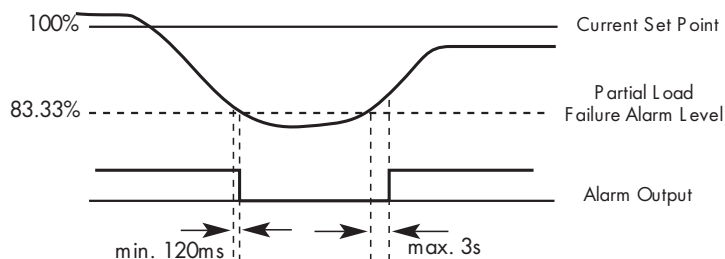
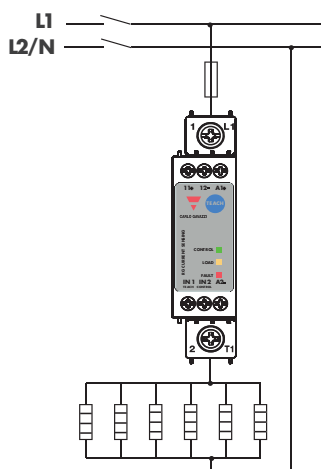

With the RGC1S, RGS1S it is possible to detect a load failure even when multiple loads are connected to one SSR. A maximum of 6 loads can be connected to the RGC1S or RGS1S. In case of a failure of 1 heater, whereby current will deviate from setpoint by 1/6 (16.67%), a partial load failure alarm is issued. The other 5 heaters will continue to be controlled as required by the specific process in the presence of a partial load failure alarm

## User interface

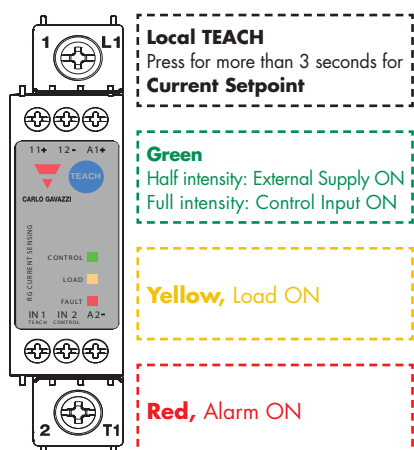

### Visual alarm indication

Locked TEACH	1 flash	
Open SSR / Open heater	2 flashes	
SSR Overtemperature	3 flashes	
SSR short circuit	4 flashes	
No TEACH setpoint	50%	
Partial load failure	100%	

## Selection guide

### RGC1S series (integrated heatsink)

Rated voltage, Blocking voltage, Switching mode	23 AAC (525 A <sup>2</sup> s) 22.5 mm	25 AAC (1800 A <sup>2</sup> s) 22.5 mm - Short	25 AAC (18000 A <sup>2</sup> s) 22.5 mm - Short	30 AAC (1800 A <sup>2</sup> s) 22.5 mm	30 AAC (6600 A <sup>2</sup> s) 22.5 mm	43 AAC (18000 A <sup>2</sup> s) 35 mm	65 AAC (18000 A <sup>2</sup> s) 70 mm	85 AAC (18000 A <sup>2</sup> s) 70 mm + fan
600 VAC, 1200 Vp ZC	RGC1S60D20GKEP	RGC1S60D25GKEP	RGC1S60D26GKEP	RGC1S60D30GKEP	RGC1S60D31GKEP	RGC1S60D41GGEP	RGC1S60D61GGEP	RGC1S60D90GGEP
	-	-	-	-	-	RGC1S60D41GGUP	RGC1S60D61GGUP	-

### RGS1S series (no heatsink)

Rated voltage, Blocking voltage, Switching mode	30 AAC (1800 A <sup>2</sup> s) 22.5 mm	65 AAC (18000 A <sup>2</sup> s) 35 mm	90 AAC (18000 A <sup>2</sup> s) 22.5 mm	-	-	-	-	-
600 VAC, 1200 Vp ZC	RGS1S60D30GKEP	-	RGS1S60D92GGEP	-	-	-	-	-
	-	RGS1S60D61GGUP	-	-	-	-	-	-

ZC = Zero cross switching

GK = box clamps for control terminals, screws for power terminals | GG = box clamps for control terminals, box clamps for power terminals  
Further details are available on online datasheets at [www.gavazziatutomation.com](http://www.gavazziatutomation.com)

CARLO GAVAZZI Automation Components. Specifications are subject to change without notice. Illustrations are for example only.

# Integrated fuse

## RGC1F series

The RGC1F is a series of solid state contactors which integrate protection by means of an on-board semiconductor fuse. The fuse is easily accessible through the front panel of the device. The series consists of two versions, the RGC1FA and the RGC1FS.

The RGC1FA is a version including just the solid state switch and the integrated fuse for protection of the SSR in case of short circuit conditions.

The RGC1FS is a more sophisticated version that apart from the integrated fuse provides also additional monitoring for load status, fuse failure, and SSR malfunction. Alarm status is visible by means of an LED and is also available through an alarm output for remote signalling.



## Fit and forget

### RGC1F series

- Integrated heatsink
- 35 mm product width
- Zero cross switching
- Ratings up to 660 VAC, 40 AAC @ 40 °C (104 °F)
- 4.5-32 VDC control voltage range
- Integrated varistor for overvoltage protection
- 100 kArms short circuit current rating acc. to UL 508
- Monitoring for load and SSR malfunction (RGC1FS)

### The RGC1FS series: 4 functions at 1 go

#### Switch

Solid state switch with integrated heatsink

#### Protection

Integrated fuse holder and fast acting semiconductor fuse for protection against short circuit currents up to 100kArms

#### Monitoring

Monitoring and detection of open fuse, load loss, solid state switch malfunction

#### Alarm

Visual indication through a red LED on the front facia and normally closed alarm output



RGC1F..40 not UL approved

## Space saving with integrated solutions

Fuse and fuse holder

40 AAC Solid State Contactor:  
**RGC1A60D40KGE**

40 AAC Solid State Contactor with  
integrated fuse in 35 mm product width:  
**RGC1FA60D40GGE**

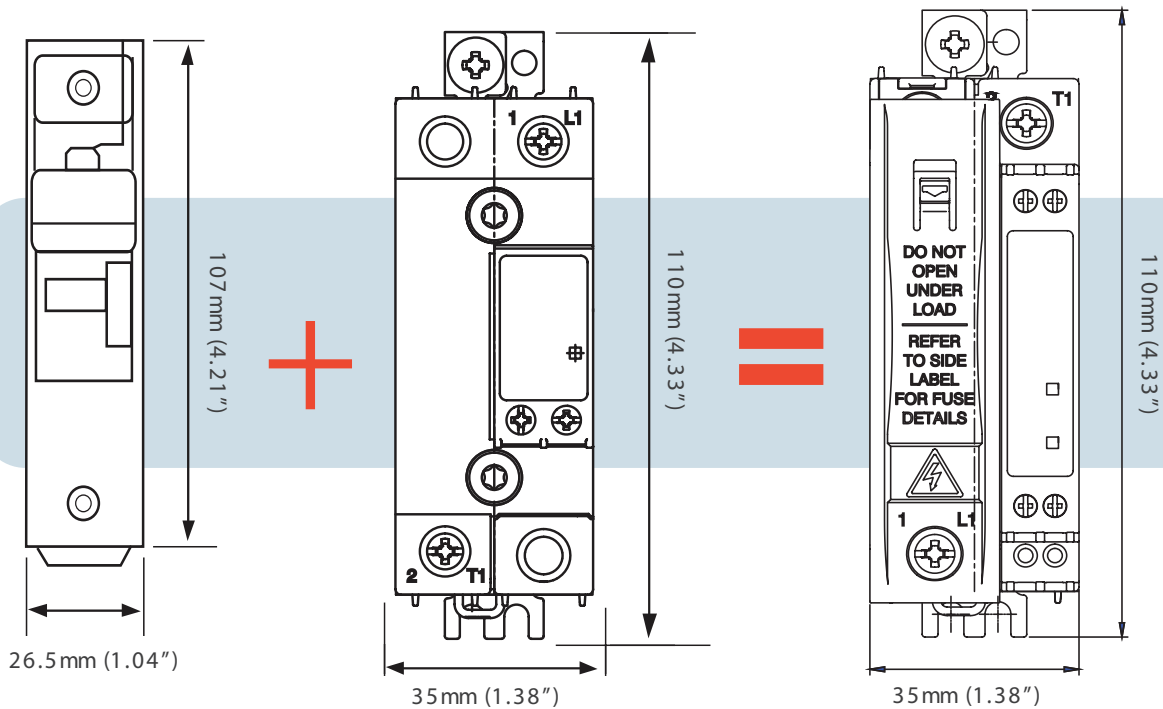

## Easy accessible fuse

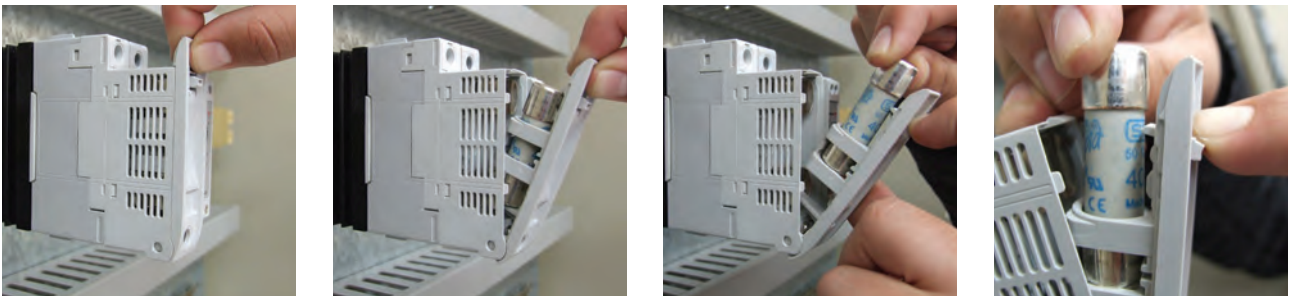

1. Preparation for opening fuse holder
2. Opening or closing the fuse holder
3. Removal or Insertion of fuse
4. Pressing downwards the fuse-holding clip to insert or remove the fuse

## Selection guide

Options	Rated voltage, Blocking voltage	Control voltage	20 AAC 35 mm	30 AAC 35 mm	40 AAC 35 mm
Fuse	230 VAC, 800 Vp	3 - 32 VDC	RGC1FA23D20GGE	RGC1FA23D30GGE	RGC1FA23D40GGE
Fuse	600 VAC, 1200 Vp	4.5 - 32 VDC	RGC1FA60D20GGE	RGC1FA60D30GGE	RGC1FA60D40GGE
Fuse + Monitoring	230 VAC, 800 Vp	3 - 32 VDC	RGC1FS23D20GGE	RGC1FS23D30GGE	RGC1FS23D40GGE
Fuse + Monitoring	600 VAC, 1200 Vp	4.5 - 32 VDC	RGC1FS60D20GGE	RGC1FS60D30GGE	RGC1FS60D40GGE

Further details are available on online datasheets at [www.gavazziautomation.com](http://www.gavazziautomation.com)

CARLO GAVAZZI Automation Components. Specifications are subject to change without notice. Illustrations are for example only.

# Proportional controllers

## RGCTP and RGS1P series

In a number of applications, the output signal from measuring and monitoring devices is an analog signal that needs to be converted to a digital signal to switch a 'common' solid state relay. This can be costly, occupies additional space in the panel and takes a longer time to install.

With the RG proportional controllers there is no need for this conversion since they can be controlled directly with an analog signal. Based on the analog input signal, the RG controller calculates the output power needed by the process and controls the load accordingly.

The RG proportional controller is equipped with user selectable switching modes to address different application such as speed control of AC fans, light dimming, very fine temperature control and reduction of visual flickering associated with short wave infrared heaters.



## Analog input, power control solutions

### Features

- Selectable switching modes
- 4-20 mA, 0-10 V, 0-5 V, 1-5 V or external pot input
- Integrated heatsink (RGCTP)
- Operational voltage up to 660 VAC
- Current rating up to 63 AAC (RGCTP), 90 AAC (RGS1P)
- Integrated output overvoltage protection
- 18,000 A<sup>2</sup>s for MCB protection coordination
- LED indication for control and load status
- 100 kArms short circuit current rating acc. to UL 508

### Benefits

#### Energy saving

Switching the load for less than a half mains cycle makes it possible to regulate speed of AC fans and to maintain a temperature closer to set point leading to potential savings in consumed energy

#### Inventory reduction

Multifunction controller that integrates various switching modes in one unit

#### Easy to use

Switching mode is easily selectable with a selector knob. Tamper proof covers, RGTMP, are available

#### Less down time, lower maintenance costs

RG controllers adopt integrated output overvoltage protection, high surge current capability and process technology that reduces thermo-mechanical stresses on output chips extending the controller lifetime



## A compact, easy to use solid state solution for power control

### Switching modes for the RGC1P, RGS1P

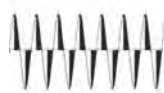

#### Mode 1: Phase angle switching

low resolution by firing at any point within a mains half cycle.

**Ideal for:** Speed control of AC fans, light dimming, fine heater control (such as infrared heaters)

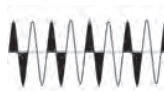

#### Mode 2: 1x Full cycle switching

1 mains full cycle resolution, less noisy than Mode 1.

**Ideal for:** Heater control of standard heater elements, long and medium wave infrared heaters

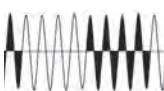

#### Mode 3: 4x Full cycle switching

4 or 16 mains full cycle resolution, heater lifetime expectancy less than Modes 1 and 2, less noisy than Mode 2.

**Ideal for:** Control of standard heater elements and heater elements with a low thermal inertia

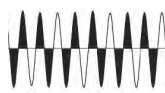

#### Mode 5: Advanced full cycle switching

non firing in mains half cycles, firing in mains full cycle at >50% input to reduce visual flickering of lamps.

**Ideal for:** Short and medium wave infrared heaters



#### Mode 6: Mode 4 with a soft start

Soft start on power up of Mode 4 and when non firing is >5sec to reduce peak inrush currents.

**Ideal for:** Heater elements which change resistance with time and temperature



#### Mode 7: Mode 5 with a soft start

Soft start on power up of Mode 5 and when non firing is >5sec to reduce peak inrush currents.

**Ideal for:** Short and medium wave infrared heaters

## Selection guide

### RGC1P..AA., RGC1P..V. (integrated heatsink)

Control input	Output voltage	Supply voltage	15 AAC (1800 A <sup>2</sup> s) 35 mm	30 AAC (1800A <sup>2</sup> s) 35 mm	43 AAC (18000 A <sup>2</sup> s) 35 mm	50 AAC (3200 A <sup>2</sup> s) 70 mm	63 AAC (18000 A <sup>2</sup> s) 70 mm	
4-20 mA	85 - 265 VAC	-	RGC1P23AA12E	RGC1P23AA30E	RGC1P23AA42E	RGC1P23AA50E	RGC1P23AA62E	
	190 - 550 VAC	-	RGC1P48AA12E	RGC1P48AA30E	RGC1P48AA42E	RGC1P48AA50E	RGC1P48AA62E	
	410 - 660 VAC	-	-	RGC1P60AA30E	RGC1P60AA42E	-	RGC1P60AA62E	
0-10 V 0-5 V 1-5 V External pot	85 - 265 VAC	24 VDC/ VAC	RGC1P23V12ED	RGC1P23V30ED	RGC1P23V42ED	RGC1P23V50ED	RGC1P23V62ED	
		90 - 250 VAC	RGC1P23V12EA	RGC1P23V30EA	RGC1P23V42EA	-	RGC1P23V62EA	
	190 - 550 VAC	24 VDC/ VAC	RGC1P48V12ED	RGC1P48V30ED	RGC1P48V42ED	RGC1P48V50ED	RGC1P48V62ED	
		90 - 250 VAC	RGC1P48V12EA	RGC1P48V30EA	RGC1P48V42EA	-	RGC1P48V62EA	
	410 - 660 VAC	24 VDC/ VAC	-	-	RGC1P60V30ED	RGC1P60V42ED	-	RGC1P60V62ED
		90 - 250 VAC	-	-	RGC1P60V30EA	RGC1P60V42EA	-	RGC1P60V62EA

### RGS1P..AA., RGS1P..V. (no heatsink)

Control input	Output voltage	Supply voltage	50 AAC (1800 A <sup>2</sup> s) 35 mm	90 AAC (18000 A <sup>2</sup> s) 35 mm	-	-	-
4-20 mA	85 - 265 VAC	-	RGS1P23AA50E	RGS1P23AA92E	-	-	-
	190 - 550 VAC	-	RGS1P48AA50E	RGS1P48AA92E	-	-	-
	410 - 660 VAC	-	RGS1P60AA50E	RGS1P60AA92E	-	-	-
0-10 V 0-5 V 1-5 V External pot	85 - 265 VAC	24 VDC/ VAC	RGS1P23V50ED	RGS1P23V92ED	-	-	-
		90 - 250 VAC	RGS1P23V50EA	RGS1P23V92EA	-	-	-
	190 - 550 VAC	24 VDC/ VAC	RGS1P48V50ED	RGS1P48V92ED	-	-	-
		90 - 250 VAC	RGS1P48V50EA	RGS1P48V92EA	-	-	-
	410 - 660 VAC	24 VDC/ VAC	RGS1P60V50ED	RGS1P60V92ED	-	-	-
		90 - 250 VAC	RGS1P60V50EA	RGS1P60V92EA	-	-	-

# Soft starters

## RGC1P..K and RGS1P..K series

Short wave infrared (SWIR) heaters are nowadays used in a wide range of different applications due to their efficiency in reaching high temperatures in a very short time and hence have the advantage of being more energy efficient over other type of heaters.

The main issue with SWIR is that they exhibit a high cold to hot resistance ratio which results in a very high inrush current on start up from a cold condition. Because of this inrush current, solid state relays have to be over-engineered to handle the surge current. Upstream protection may also trip unnecessarily on start up.

The RGC1P, RGS1P..K variants have been designed to tackle these issues. Upon starting from a cold condition a soft start is performed in order to apply the voltage and current to the load smoothly. This reduces the inrush current when SWIR heaters are switched on from a cold state.



## Solid state relays with a soft starting feature

### Features

- Soft start on power up or when non firing period is >5 seconds
- Soft start time settable to max. 5 seconds
- Integrated heatsink (RGC1P)
- Operational voltage up to 660 VAC
- Max. current rating 63 AAC (RGC1P), 90 AAC (RGS1P)
- Control voltage 24 VDC
- Integrated output overvoltage protection
- 18,000 A<sup>2</sup>s for MCB protection coordination
- LED indication for control and load status
- 100 kArms short circuit current rating acc. to UL 508

### Benefits

#### Extended heater lifetime

Eliminating the peak inrush current which can be as high as 15x I<sub>n</sub> extends the heater lifetime

#### Trouble free startup

No peak inrush current exhibited with RGC1P..K, RGS1P..K. Upstream protection does not trip unnecessarily on start up. There is no need to overengineer on the protection and the solid state relay

#### Low downtime, less maintenance costs

Ensured with integrated output overvoltage protection, high surge current capability and process technology that reduces thermal and mechanical stresses on output chips extending the controller lifetime





## Enjoy the benefits of SWIR heaters without the problematics of inrush currents

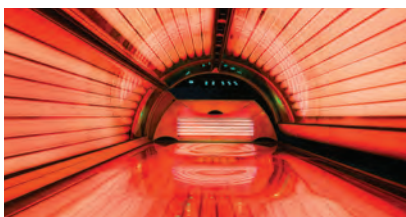

SWIR are used when lower power consumption and faster process cycles are needed.

SWIR resistance is however affected by changes in temperature. This results in a very high inrush current upon starting which can be a nuisance. The RGC1P..K and RGS1P..K are intended to reduce this inrush current by performing a soft start when starting from a cold state.

### Extending SWIR heater lifetime

Starting SWIR with a 'common' solid state relay

Using soft starting for switching on SWIR from a cold state

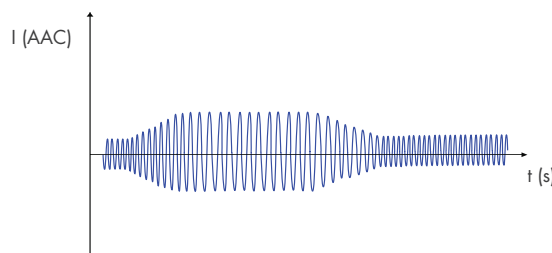
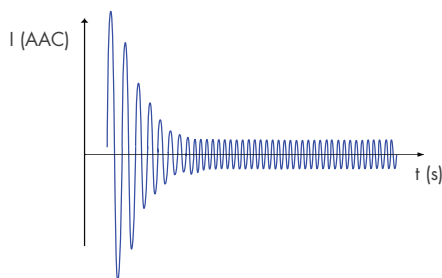

Inrush current of SWIR can be as high as **15x** the nominal current The RGC1P..K, RGS1P..K can reduce the inrush current by **> 60%**

### Soft starting only when the SWIR is in a cold state

The cause of the inrush current associated with SWIR is due to the very low resistance of such heaters when in a cold state. When the SWIR is in a hot condition the resistance is stable and no inrush current is exhibited.

For this reason, the RGC1P..K and RGS1P..K do not exhibit a soft start every time a control voltage is applied but only on startup and when control signal has been missing for the previous 5 seconds.

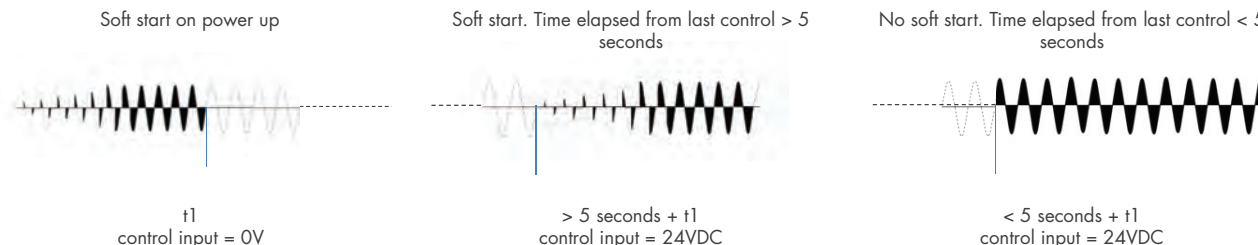

## Selection guide

### RGC1P..K.. (integrated heatsink)

Control voltage	Output voltage	Supply voltage	30 AAC (1800 A <sup>2</sup> s) 35 mm	43 AAC (18000 A <sup>2</sup> s) 35 mm	63 AAC (18000 A <sup>2</sup> s) 70 mm
24 VDC	85 - 265 VAC	24 VDC/AC	RGC1P23K30ED	RGC1P23K42ED	RGC1P23K62ED
	190 - 550 VAC	24 VDC/AC	RGC1P48K30ED	RGC1P48K42ED	RGC1P48K62ED
	410 - 660 VAC	24 VDC/AC	RGC1P60K30ED	RGC1P60K42ED	RGC1P60K62ED

### RGS1P..K.. (no heatsink)

Control voltage	Output voltage	Supply voltage	50 AAC (1800 A <sup>2</sup> s) 35 mm	90 AAC (18000 A <sup>2</sup> s) 35 mm	-
24 VDC	85 - 265 VAC	24 VDC/AC	RGS1P23K50ED	RGS1P23K92ED	-
	190 - 550 VAC	24 VDC/AC	RGS1P48K50ED	RGS1P48K92ED	-
	410 - 660 VAC	24 VDC/AC	RGS1P60K50ED	RGS1P60K92ED	-

# Slim line RG

## RGS1D and RGC1D series

Apart from switching of AC loads, the RG series caters also for switching of DC loads with the RGS1D and RGC1D series.

The RGC1D is offered with integrated heatsink whilst the RGS1D is suitable for panel mounting or for mounting on heatsinks which are specific to the particular application in which the solid state relay is to be used.

Switching is done through an IGBT power semiconductor which is protected by an integrated free-wheeling diode. Ratings extend to 1000 VDC, 25 ADC. Maximum operational temperature goes up to +80 °C (+176 °F).



## DC output solid state switches

### RGS1D series

- Without integrated heatsink
- Product width 17.5 mm
- Ratings up to 1000 VDC, 25 ADC
- 4.5 - 32 VDC control voltage range



### RGC1D series

- Integrated heatsink
- Product width 17.5 mm
- Ratings up to 1000 VDC, 15 ADC @ 40 °C (104 °F)
- 4.5 - 32 VDC control voltage range



### Repeatable and reliable

The RG solutions are fully solid state. Lifetime is not compromised by contact arcing. The need for frequent replacements is hence eliminated

### Efficient heat dissipation

This series of DC switching solid state switches boasts of high thermal efficiency thanks to the power assembly processes adopted in the RG series

### Space saving

Product width of the RGS1D and RGC1D is only 17.5 mm. This enables compact control panel designs

## Applications

### Switching of photovoltaic strings

The 1000VDC rating makes the RGS1D and the RGC1D the ideal solid state switch for the switching of strings in photovoltaic panels. A photovoltaic installation is a long term investment that can only be sustained by a using reliable equipment which ensures minimum downtimes. Unlike electromechanical solutions, the RG series is a fully solid state solution offering a much longer lifetime. Carlo Gavazzi product offering covers also monitoring and smart control systems as well as surge protectors for such applications.

Ask for more information about EOS-Array Control Systems and L-Guard series of Surge protectors from a Carlo Gavazzi representative.



### Ambient heating in train cabins

In train applications it is common to have DC voltages which can go well over 600 VDC. The 1000 VDC operational voltage associated with the RGS1D and RGC1D enables this solid state switch to be used to control DC loads used for ambient heating in such applications. Working temperature requirements are covered by the wide operating range of the RGC1D, RGS1D.



## Selection guide

Model	Output voltage	Control voltage	Connection control / power	15 ADC 17.5 mm	25 ADC 17.5 mm
No heatsink	24 - 1000 VDC	4.5 - 32 VDC	Screw / Screw	RGS1D1000D15KKE	RGS1D1000D25KKE
With integrated heatsink	24 - 1000 VDC	4.5 - 32 VDC	Screw / Screw	RGC1D1000D15KKE	-

## OUR SALES NETWORK IN EUROPE

### AUSTRIA

Carlo Gavazzi GmbH  
Ketzergasse 374,  
A-1230 Wien  
Tel: +43 1 888 4112  
Fax: +43 1 889 10 53  
office@carlogavazzi.at

### FRANCE

Carlo Gavazzi Sarl  
Zac de Paris Nord II, 69, rue de la Belle Etoile,  
F-95956 Roissy CDG Cedex  
Tel: +33 1 49 38 98 60  
Fax: +33 1 48 63 27 43  
french.team@carlogavazzi.fr

### ITALY

Carlo Gavazzi SpA  
Via Milano 13,  
I-20020 Lainate  
Tel: +39 02 931 761  
Fax: +39 02 931 763 01  
info@gavazziacbu.it

### SPAIN

Carlo Gavazzi SA  
Avda. Iparraguirre, 80-82,  
E-48940 Leioa (Bizkaia)  
Tel: +34 94 480 4037  
Fax: +34 94 431 6081  
gavazzi@gavazzi.es

### BELGIUM

Carlo Gavazzi NV/SA  
Mechelsesteenweg 311,  
B-1800 Vilvoorde  
Tel: +32 2 257 4120  
Fax: +32 2 257 41 25  
sales@carlogavazzi.be

### GERMANY

Carlo Gavazzi GmbH  
Pfnorstr. 10-14  
D-64293 Darmstadt  
Tel: +49 6151 81000  
Fax: +49 6151 81 00 40  
info@gavazzi.de

### NETHERLANDS

Carlo Gavazzi BV  
Wijkermeerweg 23,  
NL-1948 NT Beverwijk  
Tel: +31 251 22 9345  
Fax: +31 251 22 60 55  
info@carlogavazzi.nl

### SWEDEN

Carlo Gavazzi AB  
V:a Kyrkogatan 1,  
S-652 24 Karlstad  
Tel: +46 54 85 1125  
Fax: +46 54 85 11 77  
info@carlogavazzi.se

### DENMARK

Carlo Gavazzi Handel A/S  
Over Hadstenevej 40,  
DK-8370 Hadsten  
Tel: +45 89 60 6100  
Fax: +45 86 98 15 30  
handel@gavazzi.dk

### GREAT BRITAIN

Carlo Gavazzi UK Ltd  
4.4 Frimley Business Park,  
Frimley, Camberley, Surrey GU16 7SG  
Tel: +44 1 276 854 110  
Fax: +44 1 276 682 140  
sales@carlogavazzi.co.uk

### NORWAY

Carlo Gavazzi AS  
Melkeveien 13,  
N-3919 Porsgrunn  
Tel: +47 35 93 0800  
Fax: +47 35 93 08 01  
post@gavazzi.no

### SWITZERLAND

Carlo Gavazzi AG  
Verkauf Schweiz/Vente Suisse  
Sumpfstrasse 3,  
CH-6312 Steinhausen  
Tel: +41 41 747 4535  
Fax: +41 41 740 45 40  
info@carlogavazzi.ch

### FINLAND

Carlo Gavazzi OY AB  
Ahventie, 4 B  
FI-02170 Espoo  
Tel: +358 9 756 2000  
myynti@gavazzi.fi

### PORTUGAL

Carlo Gavazzi Lda  
Rua dos Jerónimos 38-B,  
P-1400-212 Lisboa  
Tel: +351 21 361 7060  
Fax: +351 21 362 13 73  
carlogavazzi@carlogavazzi.pt

## OUR SALES NETWORK IN THE AMERICAS

### USA

Carlo Gavazzi Inc.  
750 Hastings Lane,  
Buffalo Grove, IL 60089, USA  
Tel: +1 847 465 6100  
Fax: +1 847 465 7373  
sales@carlogavazzi.com

### CANADA

Carlo Gavazzi Inc.  
2660 Meadowvale Boulevard,  
Mississauga, ON L5N 6M6, Canada  
Tel: +1 905 542 0979  
Fax: +1 905 542 22 48  
gavazzi@carlogavazzi.com

### MEXICO

Carlo Gavazzi Mexico S.A. de C.V.  
Calle La Montaña no. 28, Fracc. Los Pastores  
Naucalpan de Juárez, EDOMEX CP 53340  
Tel & Fax: +52.55.5373.7042  
mexicosales@carlogavazzi.com

### BRAZIL

Carlo Gavazzi Automação Ltda.  
Av. Francisco Matarazzo, 1752  
Conj 2108 - Barra Funda - São Paulo/SP  
Tel: +55 11 3052 0832  
Fax: +55 11 3057 1753  
info@carlogavazzi.com.br

## OUR SALES NETWORK IN ASIA AND PACIFIC

### SINGAPORE

Carlo Gavazzi Automation  
Singapore Pte. Ltd.  
61 Tai Seng Avenue  
#05-06 UE Print Media Hub  
Singapore 534167  
Tel: +65 67 466 990  
Fax: +65 67 461 980  
info@carlogavazzi.com.sg

### MALAYSIA

Carlo Gavazzi Automation  
(M) SDN. BHD.  
D12-06-G, Block D12,  
Pusat Perdagangan Dana 1,  
Jalan PJU 1A/46, 47301 Petaling Jaya,  
Selangor, Malaysia.  
Tel: +60 3 7842 7299  
Fax: +60 3 7842 7399  
sales@gavazzi-asia.com

### CHINA

Carlo Gavazzi Automation  
(China) Co. Ltd.  
Unit 2308, 23/F.,  
News Building, Block 1, 1002  
Middle Shennan Zhong Road,  
Shenzhen, China  
Tel: +86 755 83699500  
Fax: +86 755 83699300  
sales@carlogavazzi.cn

### HONG KONG

Carlo Gavazzi Automation  
Hong Kong Ltd.  
Unit 3 12/F Crown Industrial Bldg.,  
106 How Ming St., Kwun Tong,  
Kowloon, Hong Kong  
Tel: +852 23041228  
Fax: +852 23443689

## OUR COMPETENCE CENTRES AND PRODUCTION SITES

### DENMARK

Carlo Gavazzi Industri A/S  
Hadsten

### MALTA

Carlo Gavazzi Ltd  
Zejtun

### ITALY

Carlo Gavazzi Controls SpA  
Belluno

### LITHUANIA

Uab Carlo Gavazzi Industri Kaunas  
Kaunas

### CHINA

Carlo Gavazzi Automation (Kunshan) Co., Ltd.  
Kunshan

## HEADQUARTERS

Carlo Gavazzi Automation SpA  
Via Milano, 13  
I-20020 - Lainate (MI) - ITALY  
Tel: +39 02 931 761  
info@gavazziautomation.com



**CARLO GAVAZZI**  
Automation Components

*Energy to Components!*

[www.gavazziautomation.com](http://www.gavazziautomation.com)

