



Automation monitoring relays

Controls

DPD, DTA, DPB... Automation monitoring relays

At Carlo Gavazzi our way of developing products always starts with listening. We begin from the final application, meeting people to understand the needs and the critical issues. We then design the products so that they really fulfil or exceed the monitoring needs and the expectations. The final result is outstanding performance.

Carlo Gavazzi implements the most sophisticated measuring techniques together with the highest attention to make the unit setup as easy as possible, we strongly foster the "Plug 'n play" philosophy. The latest DPD relay represents this philosophy by providing the possibility to our customer to get the unit already configured with own customized configuration. Besides the DPD, the other devices feature easy and intuitive settings, sometimes even not necessary.

The range features 7 different families depending upon the type of electric measurement to be monitored: threephase, voltage, current, frequency, power, power factor, temperature.

The most of them are available in 3 different housings according to required installation type: the standard DIN rail one, suitable for installation in industrial cabinets, the plug-in housing, with undecal socket, perfect for application where it is mandatory to replace the unit fast and safely and finally the Mini-D housing, for DIN rail mounting in low profile electric distribution panels typical in building automation.



Not all applications are the same...

Three phase monitoring

The main purpose of the whole family is the phase loss and phase sequence monitoring as standard. Higher tier ones can also provide neutral loss, overvoltage, undervoltage and asymmetry on both delta and star mains. The top notch device, the DPD, is capable of monitoring, besides all the above listed items, both threephase voltage and frequency mains at the same time and it can be configured by NFC through the specific App.

Current monitoring

Current monitoring relays can monitor both AC and DC currents. Current reading is made directly on the terminals, through an external shunt or current transformer. DIA53 and DIB01 through a built in current transformer can read up to 100Aac. Furthermore the DIA53 doesn't require any power supply. When it is necessary to read up to several hundred Amps, Current transformers are available to be used in conjunction with the relay.

Voltage monitoring

Voltage monitoring relays can monitor from millivolts to several hundred volts both DC or AC single phase. Depending upon model it is possible to monitor under-voltage and / or over-voltage. Low DC voltage version can be usefully employed to monitor batteries in backup systems nowadays so popular. Single phase AC are particularly indicated to verify that a specific device

has been plugged to the correct mains when the machine is used in countries with different values or with significant fluctuations.

Power and Power factor

With the power monitoring relays it is possible to detect power consumption variations of loads. Load variations can be related to load excess or load absence. Some models can monitor active power value which is generally caused by motor load variations. The DWB03 is even capable of reacting to the variation of the power direction.

Frequency

When in need of a frequency monitoring the choice is no longer restricted to the DFB, DFC or PFB, which monitor the single phase systems monitoring. With the introduction of the DPD it is now possible to use this device which offers the possibility of monitoring the frequency of three phase systems with unparalleled precision and resolution, also thanks to the digital configuration facility.

Temperature

With the new DTA71 and DTA72, recently launched, the temperature monitoring relays are now also available with Mini-D housing hence also suitable for distribution boxes and panels typical in domestic and industrial building installations.

Applications

HVAC

It is becoming more and more important to have an energy-efficient integrated HVAC system for buildings. That is why HVAC components, such as heat pumps, rooftops, chillers and air handling units need more effective control and additional functions so as to improve overall performance.

Correct motor direction means higher efficiency of the compressor (in some cases incorrect rotation means immediate breakdown). Our wide range of monitoring relays provides phase loss, phase sequence, over voltage, undervoltage, wrong frequency, asymmetry, motor temperature, overcurrent detecting immediately any wrong power supply, overload or even underload caused by load disconnections.

All these devices are aimed to reduce the system damage possibility and increase the lifetime.



Lift and escalators

For lifts, escalators and in all people moving equipment for obvious safety reasons, the direction of the motion must be 100% correct.

Phase sequence relays are a fast, reliable and easy to maintain solution. With our range of monitoring solution it is possible to detect all the possible wrong wiring, system failures and prevent them avoiding to incur into dangerous or emergency situations.

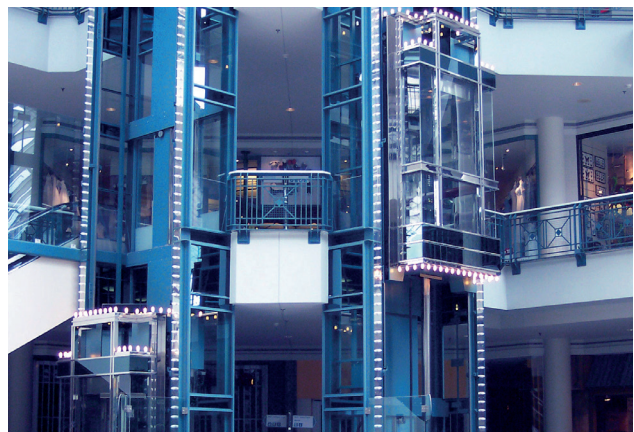

Food and beverage

Industrial plants using advanced machine for food & beverage require to quickly stop the manufacturing process in case of phase loss or to protect the motor from overload. Moreover, coffee machines, for both domestic and commercial use, must be reliably monitored in order to avoid any damage to the electromechanical elements such as pumps, motors and heating resistances.

Machinery can be protected from any kind of malfunction or damage caused by misuse, dirt, jam or wear. The result is a extended lifetime or crytical parts and reduced machine downtime.



DPD Multifunction monitoring relay

DPD is a three-phase multifunction configurable monitoring relay suitable for both Delta and Star mains. It protects loads from wrong phase sequence, neutral and phase loss, additionally voltage, frequency and asymmetry thresholds can be set and provide output signals.

The DPD is delivered with factory default settings, if they are not completely suitable they can be modified according to own requirements. DPD has two separate relay outputs. 3 front LEDs provide visual indication of outputs states and alarm discrimination.

DPD is suitable for all applications where it is necessary to monitor phase presence, correct phase sequence and the voltage value of three-phase load mains: lifts, escalators, HVAC, material handling, pumps and compressors.

Flexibility and versatility

2 part numbers cover all requirements in terms of mains type, voltage and frequency values.

2 SPDT outputs

The 2 independent outputs can be employed for different purposes according to application requirements.

Plug & play

DPD is available with 2 different factory settings. These settings should meet most of global 3 phase monitoring requirements

Customized devices availability

DPD can be ordered with customized settings also for very small quantities.

Easy NFC configuration

The DPD features NFC communication. An Android, and a Windows desktop, apps allow to build a configuration, with wanted parameters, and to send it to the device to be configured.

High compactness

The DPD features a large amount of capabilities in just 22.5mm.

Terminal connections

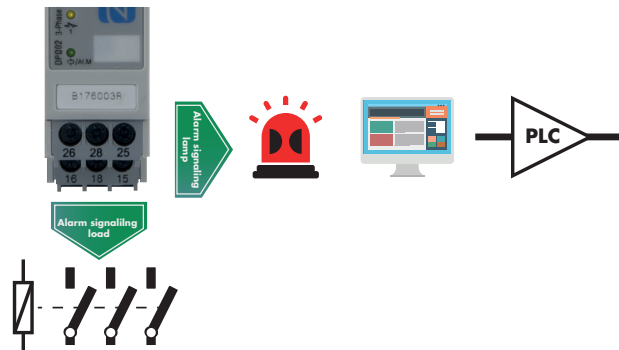
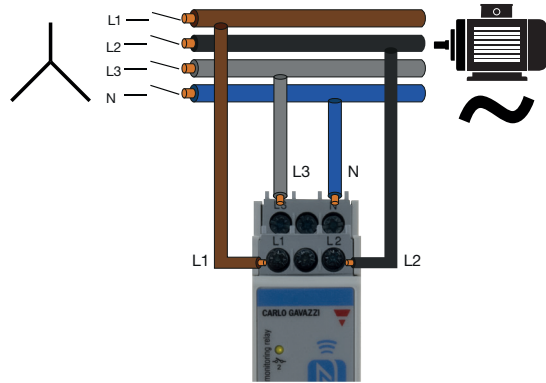
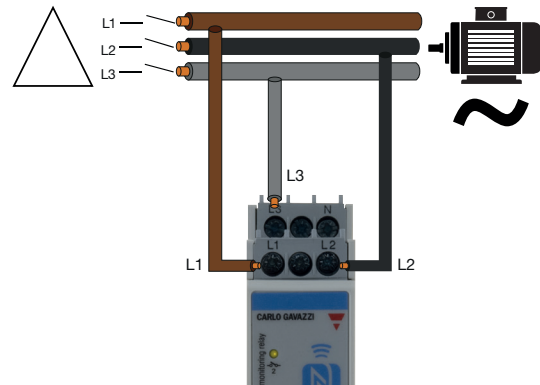

Phase Loss

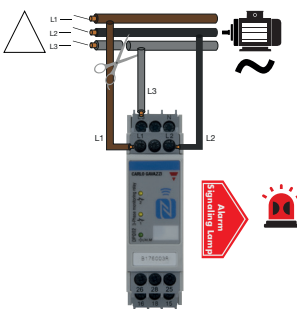

Neutral Loss

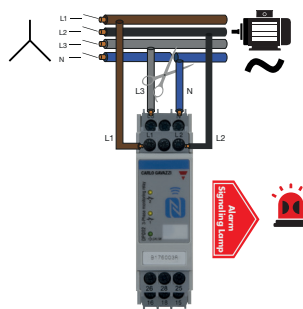

Phase Sequence

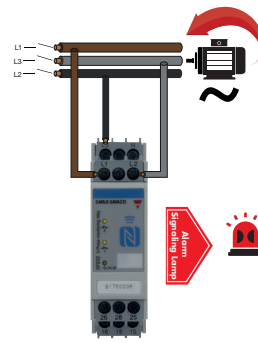

Phase Sequence

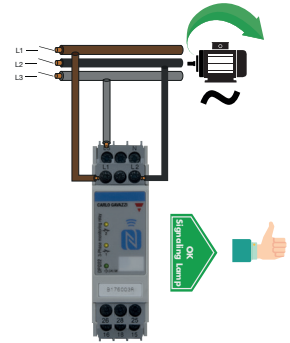

DPD Configuration & communication



Device configuration

The DPD is available with 2 different factory default configurations. If the default configurations are not suitable for the application, it is possible to configure the DPD with a proper one.

On Google Playstore is available an Android App, the Windows desktop app is available on Carlo Gavazzi website (QR Code on this page).

The App allows the user to configure the parameters hereafter listed and to send them to the device via the NFC communication.

NFC communication

NFC communication allows, once a configuration has been prepared on the PC, on a smartphone, or on a tablet to upload it to the DPD to be programmed. NFC also allows, when necessary to download the configuration from a device, modify it if necessary and then upload it to another device.

It is possible to Lock the DPD in order to avoid tampering or unauthorized configuration. The locking / unlocking procedure is managed through one of the available apps.

Priority alarms:

- Phase loss / Neutral loss (only in "Star" configured systems)
- Wrong phase sequence
- Out of range measurement

Non priority alarms:

- Undervoltage $U <$ / Overvoltage $U >$
- Overfrequency $f >$ / Underfrequency $f <$
- Threephase asymmetry

Delay

For each one of the configured setpoints it is possible to set an alarm ON and/or Alarm OFF delay.

2 Outputs

Each one of the outputs can be matched either directly or through logic AND/OR operators ("Normally Energized" / "Normally De-Energized").

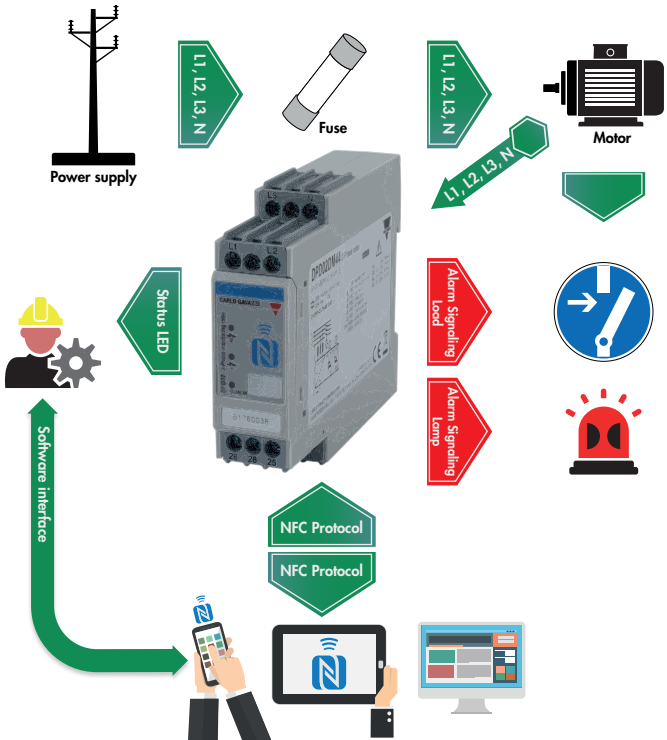
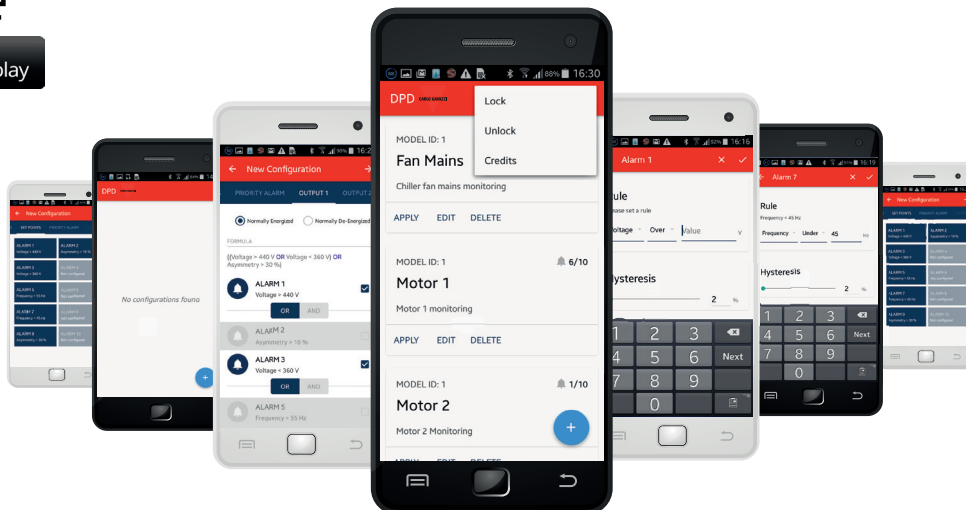

DTA

Motor thermistor relay

DTA71 and DTA72 are precise Motor thermistor monitoring relays. They can monitor up to 6 PTC temperatures. PTCs are connected in series when multiple motor windings are monitored.

DTA71 features 1 output and AUTO reset.

DTA72 features, besides the 2 outputs, the TEST switch and the local or remote manual RESET. It can also be configured as AUTO.

High operating safety

The thresholds are determined by the Motor PTC. Beyond the specified temperature the DTA output stops the motor/s.

Save time and costs

There is no need to connect other additional and expensive controllers.

Ensure continuous production process in your plant

This type of controller allows limitation of false alarms which may be the cause of useless interruptions of production systems.

One or two outputs

It is possible to select the 1 or 2 outputs version. The 2 outputs version, besides interrupting the the Motor supply, provides an additional signal for a lamp, PC or PLC.

Low profile DIN rail mounting

These devices can be mounted on classic din rail in a cabinets or in a electrical panel, the low profile mini-D housing allows installation in many applications.

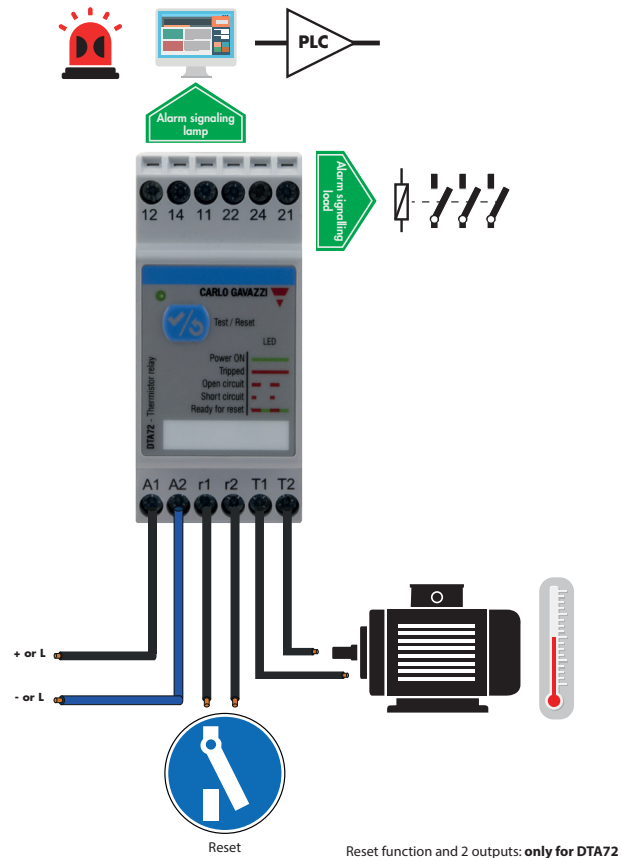

DTA

Motors and pumps monitoring



Multifunction LED

The front LED provides all operating information at a glance.

- Normal operation
- Tripped
- PTC Open circuit
- PTC Short Circuit
- Motor temperature restored

This last unique function, when the DTA72 is configured as manual reset, informs the user when the motor temperature is back to normal, with alternate red and green blinking, allowing him to successfully manually restart the operation.

As with other thermistor relays this information is not provided it often happens that the manual reset doesn't take place when the motor temperature is still above threshold and this information is not visible.

The table printed on the front panel of the DTAs provides the LED alarm key avoiding the hassle of searching such information on the manual.

Multiple motors monitoring

DTA monitors up to 6 PTCs.

Threephase motors usually feature 1 PTC embedded into each one of the 3 motor windings. In such case the PTCs are normally already connected in series inside the motor. As the DTA allows the connection of up to 6 PTCs, 2 motors can be monitored at the same time.

2 SPDT outputs



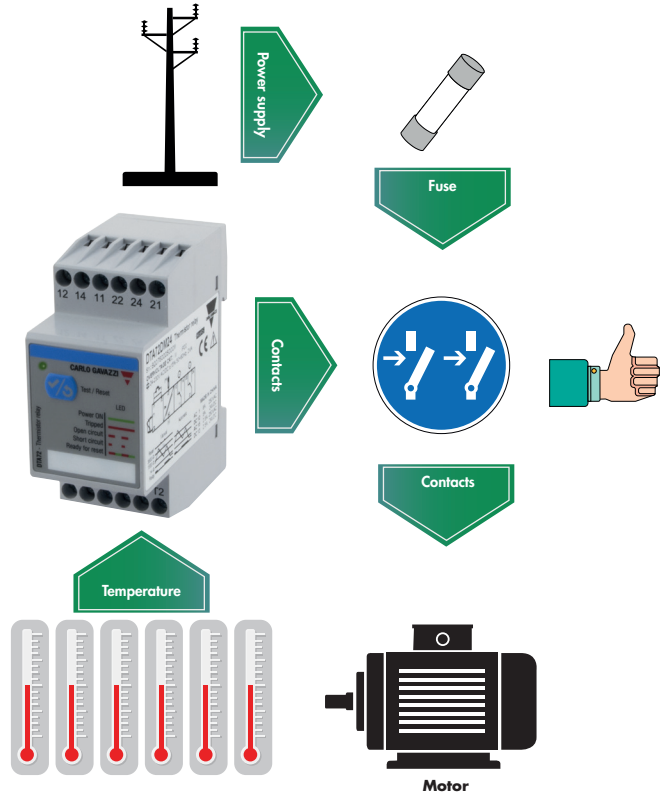

With 2 changeover relay outputs (only DTA72) it is possible for the user to use the second output for additional devices such as: PLC, PC, remote I/Os, lamps.

The 2 outputs always work in a complementary operation, when one is ON the other one is OFF and viceversa.

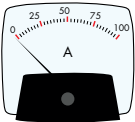

This product is extremely suitable for pumps monitoring. It can be useful in all applications where motors are used especially where overloads are frequent and may cause motor damages: pumping stations, water treatment, conveyors, material handling, HVAC, chillers. etc.

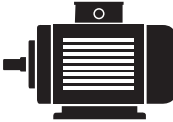
Functional level

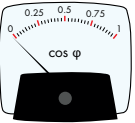
	Single functions		Dual function		Extended		Full function
Select your measured value	Single setpoint and/ or major failure reaction (phase sequence or loss)		Dual setpoints, adjustable delay, TRMS, other functions.		Dual setpoints, dual delays, 2 outputs, extended functions		Digital setting, dual measurements, 10 setpoints, 2 outputs, NFC.
 Current	DIA01 DIA53*	PIA01	DIB01 DIB02 DIB71*	PIB01 PIB02	DIC01	PIC01	
 Voltage	DUA01 DUA52* DUA55*	PUA01	DUB01 DUB02 DUB03 DUB71*	PUB01 PUB02 PUB03	DUC01	PUC01	
 Three phase	DPA01 DPA02 DPA03 DPA51* DPA53*	PPA01 PPA02 PPA03 DPA71* DPA55*	DPB01 DPB02 DPB51* DPB71*	PPB01 PPB02	DPC01 DPC02 DPC71*	PPC01 PPC71	DPD
 Frequency			DFB01	PFB01	DFC01		
 Thermistor	DTA01 DTA02 DTA71* DTA72*	PTA01 PTA02					
 Power & Power factor	DWA01	PWA01	DWB01 DWB02 DWB03	PWB01 PWB02 PWB03			
Others	DLA71* DLA73*						

First letter:

D = for DIN-rail

P = for plug in

* Mini-D DIN Rail Housing

Series

Monitoring relay range

CARLO GAVAZZI



3-phase relays DPA/DPB



- Delta or Star 3 phase TRMS Monitoring
- Independent over/under voltage setting (DPB)
- Phase sequence, phase and neutral loss
- Adjustable delay (DPB)
- SPDT 5A relay output

3-phase relays DPC



- 3 phase TRMS over and undervoltage combined with over and under frequency
- Phase sequence and phase loss
- Asymmetry
- 2 individual setpoints
- Separate adjustable delays
- 2 x 8 A SPDT output relays

3-phase relays DPD



- Delta or Star 3 phase Monitoring
- Voltage and Frequency over/under, Asymmetry, Phase and Neutral loss, Phase sequence
- Standard configuration, customizable with NFC
- Two SPDT relay outputs
- Housing 22.5mm

Current relays DIA / DIB



- Up to 100 AAC current monitoring (DIA)
- No power supply required (DIA)
- AC / DC over/under current (DIB)
- Adjustable delay and Hysteresis (DIB)
- SPDT 5 A relay output (DIB)

Current relays DIC



- TRMS AC or DC current monitoring
- Over + over or over + under or under + under
- Separately adjustable delays, adjustable hysteresis
- Programmable latch / inhibit function
- 1 or 2 x 8 A SPDT output relays

Voltage relays DUA/DUB



- DC / AC TRMS over or under voltage monitoring
- Range up to 500 VAC or DC
- Adjustable delay and hysteresis
- Programmable latching / Inhibit
- 1 x 8 A SPDT relay output

Voltage relays DUC



- TRMS AC or DC voltage monitoring
- Over + over or over + under or under + under
- Separately adjustable delays, adjustable hysteresis
- Programmable latch / inhibit function
- 1 or 2 x 8 A SPDT output relays

Frequency relays DFB / DFC



- Over and under frequency monitoring
- Rated frequency 50 Hz or 60 Hz
- Adjustable delay on alarm ON or on recovery
- Programmable latch / inhibit function
- 1 x 8 A SPDT output

Cos φ DWA



- Cosφ monitoring
- Direct reading up to 5 A or through "MI" current transformers for higher currents
- Adjustable Cosφ monitoring
- Selectable delay ON
- 1 x 8 A SPDT relay output

Power DWB



- Active power monitoring
- Direct reading up to 10 A or through "MI" current transformers for higher currents
- Selectable independent upper and lower values
- Adjustable delay ON
- 1 x 8 A SPDT relay output

Temperature relays DTA71/DTA72



- Motor thermistor monitoring
- Up to 6 PTCs Input
- Manual (only DTA72) / Auto reset
- Test button
- No setting
- 2 (1 for DTA71) SPDT relay output

Pump alternating relays DLA



- Pumps alternating relay for tanks levelmanagement
- 2 or 3 pumps management
- Delay for 2nd or 3rd pump in case of simultaneous activation
- Automatic pump rotation
- 2 or 3 SPST relay outputs

Product selection tables

Current monitoring relays



- Over current monitoring relay.
- 1-Ph AC/DC.
- Direct Input $\leq 5A$ or external CT.
- 1 setpoint, Hysteresis.
- 1 relay output.

DIA01



- Over current monitoring relay.
- 1-Ph AC/DC.
- Direct Input $\leq 5A$ or external CT.
- 1 setpoint, Hysteresis.
- 1 relay output.
- Plug-in Terminals.

PIA01



- Over current monitoring relay.
- 1-Ph AC.
- Self supplied.
- Versions from 20A to 100A.
- 1 setpoint.
- 1 transistor output.
- Hall sensing hole 12mm.

DIA53



- Over or under current 1-Ph AC/DC TRMS.
- Direct reading $\leq 5A$ or CT.
- Adjustable Delay and Hysteresis.
- 1 relay output.

DIB71



- Over or under current.
- 1-Ph AC/DC TRMS.
- Direct reading $\leq 10A$ or CT Input.
- Adjustable delay and Hysteresis.
- 1 relay output.

DIB01



- Over or under current.
- 1-Ph AC/DC TRMS.
- Direct reading $\leq 10A$ or CT Input.
- Adjustable delay and Hysteresis.
- 1 relay output.
- Plug-In terminals.

PIB01



- Over or under current.
- 1-Ph AC TRMS.
- Hysteresis, Delay.
- Hall sensing hole 12mm $\leq 100A$.

DIB01 100A



- Over or under current.
- 1-Ph AC/DC TRMS.
- CT or Shunt input signal.
- Hysteresis, Delay.
- 1 relay output.

DIB02



- Over or under current.
- 1-Ph AC/DC TRMS.
- CT or Shunt input signal.
- Hysteresis, Delay.
- 1 relay output.
- Plug-In terminals.

PIB02



- Process signals monitoring
- AC/DC: 0.5-5mA, 2-20mA, 0.1-1V, 1-10V.
- DC: -5 to +5V, -20mA to +20mA, -1 to +1V, -10 to 10V.
- 2 setpoints, 2 delay, adjustable hysteresis.
- 2 relay outputs.

DIC01



- Process signals monitoring
- AC/DC: 0.5-5mA, 2-20mA, 0.1-1V, 1-10V.
- DC: -5 to +5V, -20mA to +20mA, -1 to +1V, -10 to 10V.
- 2 setpoints, 2 delay, adjustable hysteresis.
- 2 relay outputs.
- Plug-In terminals.

PIC01

Product selection tables

3-phase monitoring relays



DPA01

- 3-Ph Delta mains.
- Up to 690V mains.
- Phase sequence and Loss.
- Self powered.
- 1 SPDT or 2SPDT relay output/s.



PPA01

- 3-Ph Delta mains.
- Phase sequence and Loss.
- Self powered.
- 1 SPDT relay output.



DPA51

- 3-Ph Delta mains.
- Phase sequence and Loss.
- Self powered.
- SPDT relay Output.



DPA71

- 3-Ph Delta mains.
- Phase sequence and Loss.
- Self powered.
- 2 SPDT relay outputs.



DPA53

- 3-Ph Delta mains.
- Phase sequence and Loss.
- Adjustable undervoltage.
- Self powered.
- SPDT relay output.



DPA55

- 3-Ph Delta mains.
- Phase sequence and Loss.
- Over and under voltage.
- Voltage window monitoring.
- Self powered.
- SPDT relay output.



DPA02

- 3-Ph Delta mains.
- Phase sequence.
- Supply voltage monitoring +/-15%.
- Self powered.
- SPDT relay output.



PPA02

- 3-Ph Delta mains.
- Phase sequence.
- Supply voltage monitoring +/-15%.
- Self powered.
- SPDT relay output.



DPA03

- 3-Ph Delta mains.
- Phase sequence and Loss.
- Adjustable undervoltage.
- Self powered.
- SPDT relay output.
- Up to 690V mains



PPA03

- 3-Ph Delta mains.
- Phase sequence and Loss.
- Adjustable undervoltage.
- Self powered.
- SPDT relay output.
- Plug-in terminals.



DPB01

- 3-Ph Delta or Star mains.
- Phase sequence and Loss.
- Over and under voltage.
- Adjustable delay.
- Self powered.
- SPDT relay Output.



PPB01

- 3-Ph Delta or Star mains.
- Phase sequence and Loss.
- Over and under voltage.
- Adjustable delay.
- Self powered.
- SPDT relay Output.
- Plug-in terminals.

Product selection tables

3-phase monitoring relays



DPB02

- 3-Ph Delta or Star mains.
- Phase sequence and loss.
- Adjustable Asymmetry and delay.
- Self powered.
- SPDT relay output.



PPB02

- 3-Ph Delta or Star mains.
- Phase sequence and loss.
- Adjustable Asymmetry and delay.
- Self powered.
- SPDT relay output.
- Plug-In terminals.



DPB51

- 3-Ph Delta mains.
- Phase sequence, neutral and phase loss.
- Adjustable over and under voltage.
- Adjustable delay.
- Self powered.
- SPDT relay output.



DPB71

- 3-Ph Delta or Star mains.
- Phase sequence and Loss.
- Adjustable over and undervoltage.
- Adjustable delay.
- Self powered.
- SPDT relay output.



DPC01
DPC01 400HZ

- 3-Ph Delta or Star mains.
- Up to 690V mains.
- Phase sequence and loss.
- Asymmetry or tolerance.
- 2 setpoint and adjustable delay.
- Self powered.
- 2 SPDT relay outputs.
- 400Hz versions.



PPC01

- 3-Ph Delta or Star mains.
- Phase sequence and Loss.
- Asymmetry or tolerance.
- 2 setpoint and adjustable delay.
- Self powered.
- 2 SPDT relay outputs.



DPC71

- 3-Ph Delta or Star mains.
- Over and under voltage.
- Phase sequence and loss.
- Asymmetry or tolerance.
- Self powered.
- 2 SPDT outputs.



PPC71

- 3-Ph Delta or Star mains.
- Over and under voltage.
- Phase sequence and loss.
- Asymmetry or tolerance.
- Self powered.
- 2 SPDT outputs.



DPC02

- 3-Ph Delta and Star mains
- Up to 690V mains.
- Phase sequence and Loss.
- Over and under voltage.
- Over and under frequency.
- 2 setpoint and delay.
- Self powered.
- 2 SPDT relay output.



DPD

- 3-Ph Delta and Star mains.
- Voltage and Frequency over/under, Asymmetry, Phase and Neutral loss, Phase sequence.
- Standard configuration, customizable NFC.
- Two SPDT relay outputs.
- Up to 400Hz

Product selection tables

Voltage monitoring relays



DUA01

- AC/DC 1-Ph Overvoltage.
- From 0.4V to 500V.
- Adjustable hysteresis.
- Programmable latching.
- SPDT relay output.



PUA01

- AC/DC 1-Ph Overvoltage.
- From 0.4V to 500V.
- Adjustable hysteresis.
- Programmable latching.
- SPDT relay output.
- Plug-In terminals.



DUA52

- DC 1-Ph Undervoltage.
- From 8 to 58VDC.
- Adjustable voltage and hysteresis.
- SPDT relay output.



DUA55

- AC 1-Ph.
- From 208 to 480Vac.
- +/-10% or +/-15% tolerance monitoring.
- Self powered.
- SPDT relay output.



DUB71

- 0.1 to 500V DC/AC 1-Ph.
- Over or under voltage.
- Adjustable hysteresis and delay.
- Programmable latching or inhibit.
- SPDT relay output.



DUB01

- 0.1 to 500V DC/AC 1-Ph.
- Over or undervoltage.
- Adjustable hysteresis and delay.
- SPDT relay output.



PUB01

- 0.1 to 500V DC/AC 1-Ph.
- Over or undervoltage.
- Adjustable hysteresis and delay.
- SPDT relay output.
- Plug-In terminals.



DUB02

- 24, 115 or 230V AC selectable.
- Adjustable over or under voltage.
- Adjustable delay.
- Programmable latch or inhibit.
- SPDT relay output.



PUB02

- 24, 115 or 230V AC selectable.
- Adjustable over or under voltage.
- Adjustable delay.
- Programmable latch or inhibit.
- SPDT relay output.
- Plug-In terminals.



DUB03

- 24, 48, 115 or 230V AC selectable.
- Adjustable over or under voltage.
- Adjustable delay and hysteresis.
- Programmable latch or inhibit.
- SPDT relay output.



PUB03

- 24, 48, 115 or 230V AC selectable.
- Adjustable over or under voltage.
- Adjustable delay and hysteresis.
- Programmable latch or inhibit.
- SPDT relay output.
- Plug-In terminals.



DUC01

- 2 to 500V DC/ AC 1-Ph.
- Over and under voltage.
- 2 Voltage and delay setpoints.
- Adjustable hysteresis.
- 2 SPDT relay outputs.



PUC01

- 2 to 500V DC/ AC 1-Ph.
- Over and under voltage.
- 2 Voltage and delay setpoints.
- Adjustable hysteresis.
- 2 SPDT relay outputs.
- Plug-In terminals.

Product selection tables

Power monitoring relays



DWA01

- 1 or 3-Ph Cosphi monitoring.
- Over or under cosphi.
- Adjustable setpoint.
- Self powered.
- Direct reading or through ext. CT.
- SPDT relay output.



PWA01

- 1 or 3-Ph Cosphi monitoring.
- Over or under cosphi.
- Adjustable setpoint.
- Self powered.
- Direct reading or through ext. CT.
- SPDT relay output.
- Plug-In terminals.



DWB01

- 3-Ph load guard.
- Up to 690V.
- Over and under cosphi.
- Adjustable setpoint.
- Manual start/stop.
- Direct reading or through ext. CT.
- SPDT relay output.



PWB01

- 3-Ph load guard.
- Up to 690V.
- Over and under cosphi.
- Adjustable setpoint.
- Manual start/stop.
- Direct reading or through ext. CT.
- SPDT relay output.
- Plug-In terminals.



DWB02

- 1 or 3-Ph Active power monitoring.
- Direct current or CT reading input.
- Over and under power.
- Programmable latching of inhibit.
- Automatic/manual start/stop.
- Separate power ON and Alarm ON delays.
- SPDT relay output.



PWB02

- 1 or 3-Ph Active power monitoring.
- Direct current or CT reading input.
- Over and under power.
- Programmable latching of inhibit.
- Automatic/manual start/stop.
- Separate power ON and Alarm ON delays.
- SPDT relay output.
- Plug-in terminals.



DWB03

- 1 or 3-Ph Active power monitoring.
- Direct current or CT reading input.
- Over and under power.
- Power direction setting.
- Programmable latching of inhibit.
- Automatic/manual start/stop.
- Separate power ON and Alarm ON delays.
- SPDT relay output.



PWB03

- 1 or 3-Ph Active power monitoring.
- Direct current or CT reading input.
- Over and under power.
- Power direction setting.
- Programmable latching of inhibit.
- Automatic/manual start/stop.
- Separate power ON and Alarm ON delays.
- SPDT relay output.
- Plug-in terminals.

Frequency monitoring relays



DFB01

- 1-Ph AC input.
- Over and under frequency.
- 24 to 240V, 50/60Hz.
- Adjustable delay.
- Programmable latching or inhibit.
- Self Supplied.
- SPDT relay output.



DFC01

- 1-Ph AC input.
- Over and under frequency.
- 24 to 240V, 50/60Hz.
- 2 Adjustable delay.
- Programmable latching or inhibit.
- Self Supplied.
- 2 SPDT relay output.



PFB01

- 1-Ph AC input.
- Over and under frequency.
- 24 to 240V, 50/60Hz.
- Adjustable delay.
- Programmable latching or inhibit.
- Self Supplied.
- SPDT relay output.
- Plug-In terminals.

Product selection tables

Motor thermistor relays



- Motor thermistor.
- Up to PTCs Input.
- Auto reset.
- No setting.
- SPDT relay output.

DTA01



- Motor thermistor.
- Up to PTCs Input.
- Auto reset.
- No setting.
- SPDT relay output.
- Plug-In terminals.

PTA01



- Motor thermistor.
- Up to PTCs Input.
- Manual/Auto reset.
- Test button.
- No setting.
- SPDT relay output.

DTA02



- Motor thermistor.
- Up to PTCs Input.
- Manual/Auto reset.
- Test button.
- No setting.
- SPDT relay output.
- Plug-in terminals.

PTA02



- Motor thermistor.
- Up to 6 PTCs Input.
- Auto reset.
- Test button.
- No setting.
- SPDT relay output.

DTA71



- Motor thermistor.
- Up to 6 PTCs Input.
- Manual/Auto reset.
- Test button.
- No setting.
- 2 SPDT relay output.

DTA72

Level management relays



- Pump alternating relay.
- For 2 or 3 pumps.
- Differential or sequential mode.
- Automatic rotation of the pumps.
- Output relay managed by one independent input contact (DLA73).

**DLA71
DLA73**

OUR SALES NETWORK IN EUROPE

AUSTRIA

Carlo Gavazzi GmbH
Ketzergasse 374,
A-1230 Wien
Tel: +43 1 888 4112
Fax: +43 1 889 10 53
office@carlogavazzi.at

FRANCE

Carlo Gavazzi Sarl
Zac de Paris Nord II, 69, rue de la Belle Etoile,
F-95956 Roissy CDG Cedex
Tel: +33 1 49 38 98 60
Fax: +33 1 48 63 27 43
french.team@carlogavazzi.fr

ITALY

Carlo Gavazzi SpA
Via Milano 13,
I-20020 Lainate
Tel: +39 02 931 761
Fax: +39 02 931 763 01
info@gavazziacbu.it

SPAIN

Carlo Gavazzi SA
Avda. Iparraguirre, 80-82,
E-48940 Leioa (Bizkaia)
Tel: +34 94 480 4037
Fax: +34 94 431 6081
gavazzi@gavazzi.es

BELGIUM

Carlo Gavazzi NV/SA
Mechelsesteenweg 311,
B-1800 Vilvoorde
Tel: +32 2 257 4120
Fax: +32 2 257 41 25
sales@carlogavazzi.be

GERMANY

Carlo Gavazzi GmbH
Pfnorstr. 10-14
D-64293 Darmstadt
Tel: +49 6151 81000
Fax: +49 6151 81 00 40
info@gavazzi.de

NETHERLANDS

Carlo Gavazzi BV
Wijkermeerweg 23,
NL-1948 NT Beverwijk
Tel: +31 251 22 9345
Fax: +31 251 22 60 55
info@carlogavazzi.nl

SWEDEN

Carlo Gavazzi AB
V:a Kyrkogatan 1,
S-652 24 Karlstad
Tel: +46 54 85 1125
Fax: +46 54 85 11 77
info@carlogavazzi.se

DENMARK

Carlo Gavazzi Handel A/S
Over Hadstenevej 40,
DK-8370 Hadsten
Tel: +45 89 60 6100
Fax: +45 86 98 15 30
handel@gavazzi.dk

GREAT BRITAIN

Carlo Gavazzi UK Ltd
4.4 Frimley Business Park,
Frimley, Camberley, Surrey GU16 7SG
Tel: +44 1 276 854 110
Fax: +44 1 276 682 140
sales@carlogavazzi.co.uk

NORWAY

Carlo Gavazzi AS
Melkeveien 13,
N-3919 Porsgrunn
Tel: +47 35 93 0800
Fax: +47 35 93 08 01
post@gavazzi.no

SWITZERLAND

Carlo Gavazzi AG
Verkauf Schweiz/Vente Suisse
Sumpfstrasse 3,
CH-6312 Steinhausen
Tel: +41 41 747 4535
Fax: +41 41 740 45 40
info@carlogavazzi.ch

FINLAND

Carlo Gavazzi OY AB
Petaksentie 2-4,
FI-00630 Helsinki
Tel: +358 9 756 2000
Fax: +358 9 756 20010
myynti@gavazzi.fi

PORTUGAL

Carlo Gavazzi Lda
Rua dos Jerónimos 38-B,
P-1400-212 Lisboa
Tel: +351 21 361 7060
Fax: +351 21 362 13 73
carlogavazzi@carlogavazzi.pt

OUR SALES NETWORK IN THE AMERICAS

USA

Carlo Gavazzi Inc.
750 Hastings Lane,
Buffalo Grove, IL 60089, USA
Tel: +1 847 465 6100
Fax: +1 847 465 7373
sales@carlogavazzi.com

CANADA

Carlo Gavazzi Inc.
2660 Meadowvale Boulevard,
Mississauga, ON L5N 6M6, Canada
Tel: +1 905 542 0979
Fax: +1 905 542 22 48
gavazzi@carlogavazzi.com

MEXICO

Carlo Gavazzi Mexico S.A. de C.V.
Calle La Montaña no. 28, Fracc. Los Pastores
Naucalpan de Juárez, EDOMEX CP 53340
Tel & Fax: +52.55.5373.7042
mexicosales@carlogavazzi.com

BRAZIL

Carlo Gavazzi Automação Ltda.
Av. Francisco Matarazzo, 1752
Conj 2108 - Barra Funda - São Paulo/SP
Tel: +55 11 3052 0832
Fax: +55 11 3057 1753
info@carlogavazzi.com.br

OUR SALES NETWORK IN ASIA AND PACIFIC

SINGAPORE

Carlo Gavazzi Automation
Singapore Pte. Ltd.
61 Tai Seng Avenue #05-06
Print Media Hub @ Paya Lebar iPark
Singapore 534167
Tel: +65 67 466 990
Fax: +65 67 461 980
info@carlogavazzi.com.sg

MALAYSIA

Carlo Gavazzi Automation
(M) SDN. BHD.
D12-06-G, Block D12,
Pusat Perdagangan Dana 1,
Jalan PJU 1A/46, 47301 Petaling Jaya,
Selangor, Malaysia.
Tel: +60 3 7842 7299
Fax: +60 3 7842 7399
sales@gavazzi-asia.com

CHINA

Carlo Gavazzi Automation
(China) Co. Ltd.
Unit 2308, 23/F.,
News Building, Block 1, 1002
Middle Shennan Zhong Road,
Shenzhen, China
Tel: +86 755 83699500
Fax: +86 755 83699300
sales@carlogavazzi.cn

HONG KONG

Carlo Gavazzi Automation
Hong Kong Ltd.
Unit 3 12/F Crown Industrial Bldg.,
106 How Ming St., Kwun Tong,
Kowloon, Hong Kong
Tel: +852 23041228
Fax: +852 23443689

OUR COMPETENCE CENTRES AND PRODUCTION SITES

DENMARK

Carlo Gavazzi Industri A/S
Hadsten

MALTA

Carlo Gavazzi Ltd
Zejtun

ITALY

Carlo Gavazzi Controls SpA
Belluno

LITHUANIA

Uab Carlo Gavazzi Industri Kaunas
Kaunas

CHINA

Carlo Gavazzi Automation (Kunshan) Co., Ltd.
Kunshan

HEADQUARTERS

Carlo Gavazzi Automation SpA
Via Milano, 13
I-20020 - Lainate (MI) - ITALY
Tel: +39 02 931 761
info@gavazziautomation.com



CARLO GAVAZZI
Automation Components

Energy to Components!

www.gavazziautomation.com

